

1-1-2015

A Novel Update to Dynamic Q Algorithm and a Frequency-fold Analysis for Aloha-based RFID Anti-Collision Protocols

Nikita Khanna

University of South Florida, niki.chawla.16@gmail.com

Follow this and additional works at: <http://scholarcommons.usf.edu/etd>

 Part of the [Electrical and Computer Engineering Commons](#)

Scholar Commons Citation

Khanna, Nikita, "A Novel Update to Dynamic Q Algorithm and a Frequency-fold Analysis for Aloha-based RFID Anti-Collision Protocols" (2015). *Graduate Theses and Dissertations*.

<http://scholarcommons.usf.edu/etd/5844>

This Thesis is brought to you for free and open access by the Graduate School at Scholar Commons. It has been accepted for inclusion in Graduate Theses and Dissertations by an authorized administrator of Scholar Commons. For more information, please contact scholarcommons@usf.edu.

A Novel Update to Dynamic Q Algorithm and a Frequency-fold Analysis for

Aloha-based RFID Anti-Collision Protocols

by

Nikita Khanna

A thesis submitted in partial fulfillment
of the requirements for the degree of
Master of Science in Electrical Engineering
Department of Electrical Engineering
College of Engineering
University of South Florida

Major Professor: Ismail Uysal, Ph.D.
Nasir Ghani, Ph.D.
Ravi Sankar, Ph.D.

Date of Approval:
March 20, 2015

Keywords: Aloha, Gen 2, 2-fold frequency division, QSCC algorithm, QFCC algorithm

Copyright © 2015, Nikita Khanna

DEDICATION

I dedicate my work to my family and my professor Dr. Ismail Uysal.

ACKNOWLEDGMENTS

I would like to express my deepest gratitude to my professor Dr. Ismail Uysal for his excellent guidance, patience, motivation and understanding throughout my graduate studies. He was a constant source of knowledge and inspiration. I could not have imagined having a better advisor and mentor for my thesis.

I would also like to thank my committee members Dr. Nasir Ghani and Dr. Ravi Sankar for their valuable time and suggestions.

I warmly thank and appreciate my father, Vipin Chawla, my mother, Niru Chawla and my brother, Dipesh Chawla for their unconditional love, support and encouragement throughout my life. They made me what I am today. I would also like to thank my in-laws for their encouragement. Lastly and most importantly, I would especially like to thank my husband, Dr. Rohit Khanna for his guidance, affection, motivation and support to complete my thesis.

TABLE OF CONTENTS

LIST OF TABLES.....	iv
LIST OF FIGURES.....	v
ABSTRACT.....	vii
CHAPTER 1: INTRODUCTION.....	1
1.1 Introduction to RFID.....	1
1.2 History of RFID.....	2
1.3 RFID System Operation.....	4
1.4 RFID System Overview.....	5
1.4.1 RFID Tags.....	5
1.4.1.1 Passive Tags.....	6
1.4.1.2 Semi-Passive Tags.....	7
1.4.1.3 Active Tags.....	7
1.4.2 RFID Reader.....	8
1.4.3 Data Processing Subsystems.....	9
1.5 Operating Frequencies in RFID.....	9
1.5.1 Low Frequency (LF).....	10
1.5.2 High Frequency (HF).....	10
1.5.3 Ultra High Frequency (UHF).....	10
1.5.4 Microwave.....	11
1.5.5 Ultra Wideband (UW).....	11
1.6 Communication Principles.....	12
1.6.1 Near-Field RFID.....	12
1.6.2 Far-Field RFID.....	13
1.7 Applications of RFID.....	14
1.7.1 Identification.....	15
1.7.2 Asset Tracking.....	15
1.7.3 Healthcare.....	15
1.7.4 Animal Tracking.....	16
1.7.5 Supply Chain Management.....	16
1.7.6 Manufacturing.....	16
1.7.7 Retailing.....	17
1.7.8 Payment Systems.....	17
1.7.9 Fashion Industry.....	17
1.7.10 Access Control.....	18
1.7.11 Entertainment Industry.....	18

CHAPTER 2: REVIEW OF ANTI-COLLISION ALGORITHMS FOR PASSIVE RFID SYSTEMS	19
2.1 Classification of RFID Anti-Collision Protocols.....	19
2.1.1 Space Division Multiple Access (SDMA) Protocols.....	20
2.1.2 Frequency Division Multiple Access (FDMA) Protocols	20
2.1.3 Code Division Multiple Access (CDMA) Protocols	21
2.1.4 Time Division Multiple Access (TDMA) Protocols	21
2.1.4.1 Reader Driven Protocols	21
2.1.4.2 Tag Driven Protocols.....	21
2.2 Aloha Based Protocols.....	22
2.2.1 Pure Aloha (PA).....	22
2.2.1.1 Pure Aloha with Muting	23
2.2.1.2 Pure Aloha with Slow Down	23
2.2.1.3 Pure Aloha with Fast Mode	23
2.2.1.4 Pure Aloha with Fast Mode and Muting	24
2.2.1.5 Pure Aloha with Fast Mode and Slow Down	24
2.2.2 Slotted Aloha (SA)	24
2.2.2.1 Slotted Aloha with Muting or Slow Down.....	25
2.2.2.2 Slotted Aloha with Early End.....	25
2.2.2.3 Slotted Aloha with Early End and Muting	26
2.2.2.4 Slotted Aloha with Slow Down and Early End	26
2.2.3 Framed Slotted Aloha (FSA).....	26
2.2.3.1 Basic Framed Slotted Aloha (BFSA).....	27
2.2.3.1.1 BFSA with Non-Muting	27
2.2.3.1.2 BFSA with Muting	28
2.2.3.1.3 BFSA with Non-Muting and Early End	28
2.2.3.1.4 BFSA with Muting and Early End.....	28
2.2.3.2 Dynamic Framed Slotted Aloha (DFSA).....	28
2.2.3.3 Enhanced Dynamic Framed Slotted Aloha (EDFSA)	28
2.3 Tree Based Protocols.....	29
2.4 RFID Anti-Collision Standards.....	30
CHAPTER 3: EFFECTS OF 2-FOLD FREQUENCY DIVISION APPROACH ON EXISTING ANTI-COLLISION ALGORITHMS	32
3.1 2-Fold Frequency Division Approach.....	32
3.2 Filters.....	33
3.2.1 Low Pass Filter	34
3.2.2 High Pass Filter.....	36
3.3 Performance Comparison of Select State-of-the-Art Protocols using 2-Fold Frequency Division.....	38
3.3.1 Framed Slotted Aloha Protocol	38
3.3.2 Reservation Slot with Multi-Bits Aloha Protocol	39
CHAPTER 4: PARAMETRIC COMPARATIVE STUDY AND DYNAMIC MODIFICATION OF GEN 2 STANDARD ANTI-COLLISION ALGORITHM.....	43
4.1 EPCglobal Class 1 Generation 2 Standard Protocol	43

4.2 Proposed Algorithms	47
4.2.1 Q-Slot-Collision Counter (QSCC) Algorithm	47
4.2.2 Q-Frame-Collision Counter (QFCC) Algorithm	48
4.3 Performance Evaluation	49
4.3.1 Performance Analysis of QSCC Algorithm.....	50
4.3.2 Performance Analysis of QFCC Algorithm.....	51
CHAPTER 5: CONCLUSION	57
REFERENCES.....	59

LIST OF TABLES

Table 1.1: History of RFID	4
Table 1.2: Difference between different types of tags	8
Table 2.1: Comparison of aloha based protocols	29
Table 2.2: Comparison of tree based protocols.....	30
Table 2.3: Comparison between aloha based and tree based protocols.....	30
Table 2.4: ISO standards	31
Table 2.5: EPCglobal standards	31
Table 4.1: Different efficiency values for number of tags, N=10 to 100	50
Table 4.2: Different efficiency values for number of tags, N =100 to 1000	51
Table 4.3: Maximum and minimum efficiency values of Gen 2 and QFCC algorithm.....	54

LIST OF FIGURES

Figure 1.1:	RFID system operation	5
Figure 1.2:	Passive RFID tags	6
Figure 1.3:	Semi-passive RFID tags	7
Figure 1.4:	Active RFID tag.....	7
Figure 1.5:	RFID reader	9
Figure 1.6:	Applications of RFID	14
Figure 1.7:	Disney's RFID band.....	18
Figure 2.1:	Classification of RFID anti-collision protocols	20
Figure 2.2:	Example of working of pure aloha.....	22
Figure 2.3:	Example of working of slotted aloha	25
Figure 2.4:	Example of working of framed slotted aloha	27
Figure 3.1:	Circuit diagram of low pass filter	34
Figure 3.2:	Frequency response of low pass filter	35
Figure 3.3:	Circuit diagram of high pass filter.....	36
Figure 3.4:	Frequency response of high pass filter	37
Figure 3.5:	Efficiency of FSA protocol with and without 2-fold frequency division approach.....	39
Figure 3.6:	Efficiency of RSMBA protocol with and without 2-fold frequency division approach.....	42
Figure 4.1:	Communication between reader and tag for a successful slot.....	45
Figure 4.2:	Link timing and communication for a successful slot	45

Figure 4.3:	Link timing and communication for a collision and idle slot.....	45
Figure 4.4:	Algorithm for choosing Q parameter in Gen 2 protocol.....	46
Figure 4.5:	Algorithm for choosing the value of Q parameter in QSCC protocol.....	48
Figure 4.6:	Algorithm for choosing the value of Q parameter in QFCC protocol	49
Figure 4.7:	Efficiency for Gen 2 and QFCC algorithm for Q = 2 and N = 10 to 100.....	52
Figure 4.8:	Efficiency for Gen 2 and QFCC algorithm for Q = 4 and N = 10 to 100.....	52
Figure 4.9:	Efficiency for Gen 2 and QFCC algorithm for Q = 2 and N = 100 to 1000.....	53
Figure 4.10:	Efficiency for Gen 2 and QFCC algorithm for Q = 4 and N = 100 to 1000.....	53
Figure 4.11:	Latency for Gen 2 and QFCC algorithm for Q = 4 and N = 100 to 1000.....	55
Figure 4.12:	Efficiency for Gen 2 and QFCC algorithm for Q = 8 and N = 10 to 100.....	56

ABSTRACT

Radio frequency identification (RFID) systems are increasingly used for a wide range of applications from supply chain management to mobile payment systems. In a typical RFID system, there is a reader/interrogator and multiple tags/transponders, which can communicate with the reader. If more than one tag tries to communicate with the reader at the same time, a collision occurs resulting in failed communications, which becomes a significantly more important challenge as the number of tags in the environment increases. Collision reduction has been studied extensively in the literature with a variety of algorithm designs specifically tailored for low-power RFID systems.

In this study, we provide an extensive review of existing state-of-the-art time domain anti-collision protocols which can generally be divided into two main categories: 1) aloha based and 2) tree based. We explore the maximum theoretical gain in efficiency with a 2-fold frequency division in the ultra-high frequency (UHF) band of 902-928 MHz used for RFID systems in the United States. We analyze how such a modification would change the total number of collisions and improve efficiency for two different anti-collision algorithms in the literature: a relatively basic framed-slotted aloha and a more advanced reservation slot with multi-bits aloha. We also explore how a 2-fold frequency division can be implemented using analog filters for semi-passive RFID tags. Our results indicate significant gains in efficiency for both aloha algorithms especially for midsize populations of tags up to 50.

Finally, we propose two modifications to the Q-algorithm, which is currently used as part of the industry standard EPC Class 1 Generation 2 (Gen 2) protocol. The Q-Slot-Collision-Counter (QSCC) and Q-Frame-Collision-Counter (QFCC) algorithms change the size of the frame more dynamically depending on the number of colliding tags in each time slot with the help of radar cross section technique whereas the standard Q-algorithm uses a fixed parameter for frame adjustment. In fact, QFCC algorithm is completely independent of the variable “C” which is used in the standard protocol for modifying the frame size. Through computer simulations, we show that the QFCC algorithm is more robust and provide an average efficiency gain of more than 6% on large populations of tags compared to the existing standard.

CHAPTER 1: INTRODUCTION

1.1 Introduction to RFID

RFID (Radio Frequency Identification) is an automatic identification technology that uses radio frequencies for transferring information. This wireless sensor technology is based on the detection of electromagnetic signals. A RFID system is supposed to identify and track an object using radio frequencies. The RFID reader reads the information from the specified source just like the other identification systems like barcodes, fingerprints or eyes' iris. A data processing subsystem or server further processes this information. RFID systems may be slightly more costly than barcode systems but they have various advantages such as:

- RFID tags can be read without line of sight, so tag's position is not as much a constraint as in barcode systems. For instance, RFID tags can be read even if they are covered or packed inside a box.
- Multiple tags can be read at the same time saving a lot of time.
- Tags can have read and write memory capability.
- Tag detection does not require human supervision, so it reduces employment cost and decreases human errors.
- RFID tags have relatively longer read ranges.
- Tags reduces inventory control cost and time.

- RFID tags can be combined with sensors for additional functionalities like temperature monitoring.
- Tags can have computational capabilities such as calculating product quality.

Due to these beneficial properties and improving technology, the applications of RFID have been increasing in recent years.

1.2 History of RFID

The beginning of modern radio communication was in 1906 when Ernst F.W. Alexanderson demonstrated the generation of first continuous wave (CW) radio and transmission of radio signals [1]. During World War II, radar was used for detecting the approaching planes by sending out radio waves and locating the position of plane by the reflection of radio waves. To distinguish their planes from others, Germans rolled their planes to change the reflection of radar signal. Later, British developed the first active identify friend or foe (IFF) system. For that, they put a transponder on each of their airplane, which received the interrogating signal from base and sent back a signal to identify the plane as friendly [2]. This technology is still used today to control the air traffic.

There were many technological advances made related to radio waves during 1950s-1970s. In 1948, Harry Stockman published “Communication by Means of Reflected Power”. In 1964, R.F.Harrington wrote a paper “Theory of Loaded Scatterers” showing the study about electromagnetic theory related to RFID. In the late 1960s, companies called Sensormatic and Checkpoint together with another company called Knogo,

developed the electronic article surveillance (EAS) equipment to face the challenges of merchandise theft.

Large companies, such as Raytheon and RCA developed electronic identification systems in 1973 and in 1975, respectively. During the 70s, research laboratories and universities, such as the Los Alamos Scientific Laboratory and Northwestern University were involved in RFID research. The International Bridge Turnpike and Tunnel Association (IBTTA) and the United States Federal Highway Administration organized a conference in 1973 on RFID concluding that there was no national interest in the development of a standard for vehicle identification. In 1978, R.J. King wrote a book about microwave homodyne techniques which has been used as the basis for the development of the theory and practice which are used in backscatter RFID systems.

The first commercial application of RFID was developed in Norway in 1987 and was followed by the Dallas North Turnpike in the United States in 1989. During the 1990s, some American states used this technology for toll collection and traffic management system.

Texas Instruments developed the TIRIS system which was used in many automobiles applications. Many European companies, such as Microdesign, CGA, Alcatel, Bosch and Phillips spin-offs of Combitech, Baumer and Tagmaster developed a pan-European standard for tolling applications in Europe which evolved into a common standard for electronic tolling. The use of RFID for electronic toll collection had expanded to 3,500 traffic lanes by 2001.

Consequently, over the years, RFID applications emerged in various areas such as transport, access control, animal identification, tracking nuclear material and electronic toll collection. This trend is exponentially increasing in the 21st century due to tag's price reduction and RFID standardization. Today, RFID tags are manufactured and even printed in the form of labels, to be placed on the objects which are to be managed and tracked.

Table 1.1: History of RFID [1]

Decade	Event
1940–1950	Radar refined and used, major World War II development effort. RFID invented in 1948.
1950–1960	Early explorations of RFID technology, laboratory experiments.
1960–1970	Development of the theory of RFID. Start of applications field trials.
1970–1980	Explosion of RFID development. Tests of RFID accelerate. Very early implementations of RFID.
1980–1990	Commercial applications of RFID enter mainstream.
1990–2000	Emergence of standards. RFID widely deployed. RFID becomes a part of everyday life.
2000–	RFID growth continues exponentially.

1.3 RFID System Operation

In RFID systems, the objects to be identified or tracked are tagged with RFID tags. RFID reader interrogates the tags by broadcasting signal through antenna. When tags receive the reader's signal, it is energized enough from the signal to send back an identified response. The obtained information is sent to database subsystem or server or computer system by the reader for further computational work or querying for tag's

information according to the system's application. Figure 1.1 shows the working of the RFID system.

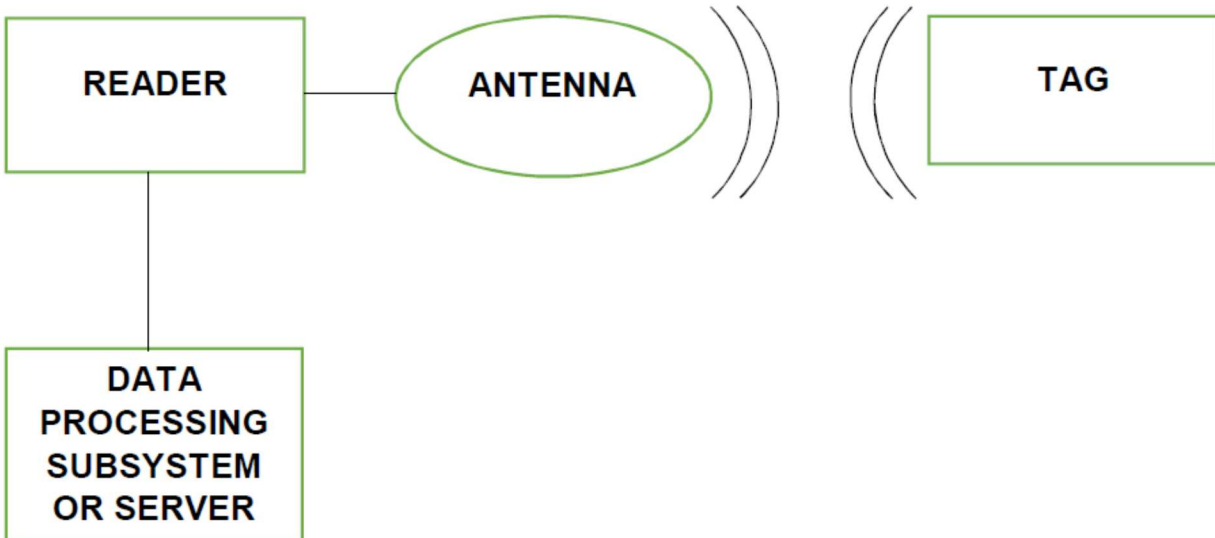

Figure 1.1: RFID system operation

1.4 RFID System Overview

RFID system consists of three main components: RFID tags, RFID reader and data processing subsystem or server.

1.4.1 RFID Tags

RFID tags (or transponders) consist of two main components: integrated circuit or microchip and antenna. The integrated circuit consists of microprocessor, memory and antenna. The antenna decides the reading range of the tag. The memory of tag is used to store information like its ID or any function tag needs to perform. Depending on the data storage capabilities, tags can be designed to be read only or read and write. For read only tags, the unique tag ID is written at manufacturing level, which points to a

database, providing all the information about the tag. Whereas read and write tags have re-writable memory which allows user to read the data and change it if required.

Tags are also categorized according to their power source. There are generally three types of tags:

1.4.1.1 Passive Tags

Passive tags have no power of their own and uses the power generated by continuous electromagnetic waves coming from the reader's signal. Due to lack of power supply source, these tags can be quite cheap, small, provide small reading range and are more durable.



Figure 1.2: Passive RFID tags

1.4.1.2 Semi-Passive Tags

Semi-passive tags have a battery to operate the microprocessor but uses the power for communication from the reader's signal.



Figure 1.3: Semi-passive RFID tags

1.4.1.3 Active Tags

Active tags have their own power supply like a battery which is used for both the microprocessor function and for communications. These tags are usually read and write type of tags, contains more memory, bulkier, provides large reading range, are expensive and have limited life.



Figure 1.4: Active RFID tag

Table 1.2: Difference between different types of tags

Features and Tags	Passive RFID Tag	Semi-Passive RFID Tag	Active Tag
Tag power source	Power from reader's signal	Internal battery for chip and power from reader's signal for communication	Internal battery in tag
Response	Weak	Strong	Strong
Size	Small	Medium	Big
Cost	Cheap	Less expensive	Most expensive
Potential life	Very Long	Long	Short
Read range	Short (10 centimeters to few meters)	Long (Hundreds of meters)	Long (Hundreds of meters)

1.4.2 RFID Reader

The RFID reader interrogates RFID tags using radio frequency communication and reads the information stored in the tag. It is also used to write the information on re-writable tags. There are two categories of readers based on their mobility: hand held readers and fixed readers. Hand held readers can read or write tags everywhere as they are mobile and can move to different places. Fixed readers are mostly used in applications such as toll payment, identification of people and goods at a gate as they are unable to move and fixed in nature. Also readers can be classified as multicast and unicast based on their function. Multicast readers can read all the tags in the reading range whereas unicast readers can read specific tags. For keeping the reader's function simple, readers send the received data to the data processing subsystem, back end database or server. So, by doing this, reader delegates most of the computational work to the connected server or database.



Figure 1.5: RFID reader

1.4.3 Data Processing Subsystems

The data processing subsystems or servers are used to overcome the computational limitations of tags and readers. Tags have limited memory space due to which they cannot store all the information required by the reader. So, all the information is stored in database and tags contain the address of the information so that reader can look in database for the required information. It also helps in reducing the cost of reader by doing all the computational work needed for the process.

1.5 Operating Frequencies in RFID

There are different RFID systems, which operate at different radio frequencies. Operating frequency determine the type of RFID tags used as the size and shape of antenna varies with frequency. Each frequency range has different operating ranges, performance and power requirement. There may be different regulations or restrictions

for different frequency ranges, which can determine the application they can be used for.

1.5.1 Low Frequency (LF)

Low frequency RFID tags operate typically in 125-134 kHz range. Since most of the LF tags are passive and get their power through induction, they have very short read range of less than 0.5 meters. They also have very low data transfer rate of less than 1 kbit per second as compared to other operating frequencies. LF tags are high cost tags as a large antenna is required for low frequencies.

LF tags can be used in rugged environment and can operate in proximity to metal and liquids. These tags are used in laundry management, car immobilization, access control system, vehicle identification and animal tracking.

1.5.2 High Frequency (HF)

High frequency RFID tags operate at 13.56 MHz frequency. They also have a short read range of 1 meter. They have higher data transfer as compared to LF tags, which is 25 kbits per second. HF tags are less expensive than LF tags.

HF tags are used for many applications like building access control, contact-less credit cards, ID badges, asset-tracking, baggage control, etc.

1.5.3 Ultra High Frequency (UHF)

Ultra high frequency RFID tags operate in 868-928 MHz range. Different ranges are used in various countries like European tags operate in 868-870 MHz range while in

US, 902-928 MHz range is used for RFID tags. These tags have a large read range of 3 meters as compared to LF and HF tags. They also have higher data transfer rate of 100 kbits per second. UHF tags are cheaper than LF and HF tags as IC designs have improved a lot.

UHF RFID tags are widely used in item tracking, parking access, toll collection and supply chain management applications these days.

1.5.4 Microwave

Microwave tags operate at either 2.45 or 5.8 GHz. This is also known as Super-High frequencies (SHF). These tags have very large reading range of up to 10 meters. They can transfer data at the rate of 100 kbits per second. Microwave tags are more expensive compared to LF, HF and UHF tags.

Microwave RFID technology is being used recently in many applications such as fleet identification, airplane baggage tracking, production line tracking and electronic toll application.

1.5.5 Ultra Wideband (UWB)

This is a fairly recent technology being applied in RFID. UWB tags use very low power as compared to other frequencies. UWB tags operate from 3.1 to 10.6 GHz. They have a very large line-of-sight read range of 200 meters.

Since UWB is compatible with liquids and metals, they can be used in asset tracking in hospitals.

1.6 Communication Principles

There are two fundamental methods in which a reader can communicate with a tag: magnetic induction and electromagnetic (EM) wave capture. Both designs are based on EM properties of an RF antenna - the near field and the far field.

1.6.1 Near-Field RFID

The near-field communication is mostly used for the RFID systems operating in LF or HF bands. The basis of near-field coupling between tag and reader is Faraday's principle of magnetic induction. There is a coil in the reader, which produces alternating magnetic field around it if a large alternating current is passed through it. When a tag enters in this magnetic field, there is alternating voltage produced across a small coil incorporated in the tag. This voltage is then rectified to a DC voltage and coupled to a capacitor to store the charge, which can be used as power for the chip in tag.

After the tag is energized, reader communicates with tag using amplitude modulation. The reader modulates its magnetic field amplitude according to the information or signal to be transmitted to the tag. For sending the data to reader, tag uses load modulation. There will be a small magnetic field created whenever any current is drawn from the tag coil. This magnetic field will oppose the reader's field. The reader coil will detect this small increase in its current flowing through it. Since this current is proportional to the load applied to the tag's coil, it is called load modulation. Thus, with varying the load applied to tag's coil over the time, a signal can be created with varying magnetic field strength. This signal can represent tag's ID or any other data which is to be sent from tag to reader.

Apart from the simple operation of near-field, there are some limitations to it. The range within which magnetic induction can be used is $c/2\pi f$, where c is the speed of light and f is the frequency. So, if frequency is increased, the distance for near field coupling operation will decrease and vice versa. Even the energy used for induction is dependent on distance between the tag and the reader. The magnetic field drops by $1/r^3$, where r is the separation of tag and reader along a center line perpendicular to the coil's plane [3]. So, this limits the use of near-field communication when there is more number of tags in the reader's area.

1.6.2 Far-Field RFID

Far-field communication is used in RFID systems operating in the UHF and microwave bands. In this, the dipole antenna attached to the reader emits electromagnetic (EM) waves which are captured by the smaller dipole antenna in the tag. This produces an alternating potential difference across the arms of the dipole in tag. This potential is rectified and when linked to a capacitor, power is stored which can be used in the working of tag's circuit.

The information is transmitted by using back scattering in far-field communication. The tag's antenna is designed with precise dimensions, which can be tuned to a particular frequency where it can absorb most of the energy. If there is an impedance mismatch at this frequency, the tag's antenna reflects back some of the energy as tiny waves, which can be detected by using a sensitive radio receiver. Thus, the tag can reflect back more or less of incoming signal encoding its ID by changing its antenna's impedance over time.

The limitations to far-field communication's range are the amount of energy transferred to the tag from the reader and the sensitivity of reader's radio receiver to the reflected signal. The two attenuations – the first when the EM waves radiate from reader to tag, and the second when the reflected signal goes back to reader from tag, are based on the inverse square law. According to inverse square law, the returning energy is $1/r^4$, where r is the separation of the tag and reader [3]. But with advancing technology leading to shrinkage of size, production of inexpensive radio receivers and Moore's law, the power requirements of any tag at a given frequency is decreased. So, tags can be read at increasingly greater distances and faster speeds.

1.7 Applications of RFID

RFID is a growing technology and is becoming more popular in all fields.

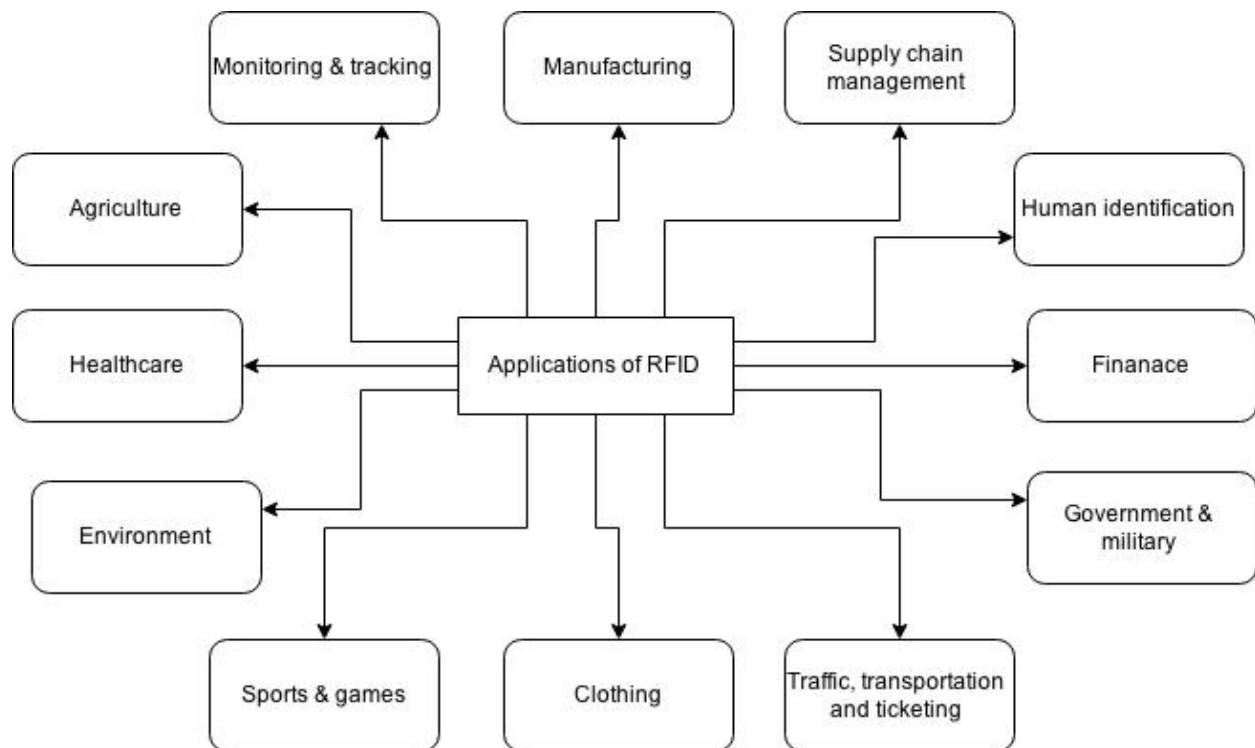

Figure 1.6: Applications of RFID

The following are a few commonplace applications of RFID.

1.7.1 Identification

The first application of RFID was identification, which was used to identify the airplanes during World War II. It is now being used for identification in a wide range of fields like tracking airplanes, ships, shipping containers, train cars, etc. RFID technology is also used in e-passports in several countries [4] to increase identity protection.

1.7.2 Asset Tracking

It is one of the very common applications of RFID. RFID technology is less costly as compared to other tracking systems like GPS or GSM. Many companies use RFID tags to protect their products from getting lost or stolen. For tracking, tags operating at higher frequency ranges are used as they provide longer read ranges. This technology is used in libraries or bookstores for tracking books [5], pallet tracking, building access control, airline baggage tracking [6], apparel and pharmaceutical items tracking.

1.7.3 Healthcare

Healthcare industry has started using RFID technology extensively over the past decade. It is being used in healthcare supply chain, preventing drug counterfeiting and increasing patient safety. The RFID tags can track the patients, medical equipment and drugs being used [7] [8]. Also, they are used in tracking used or discarded drugs packaging so that the companies who attempt to sell counterfeit pharmaceuticals do not reuse it.

1.7.4 Animal Tracking

RFID technology is used for tracking animals in various countries [9]. Glass encapsulated tags are implanted in animals to keep track of them. Usually these tags have short reading ranges. If not implanted, these tags are pierced or clamped to their ears or attached to collar or swallowed. Such tags are more rugged and have large reading ranges. These are used in livestock tracking their location in a farm. It is also used to track cows, dogs and other animals by their owners.

1.7.5 Supply Chain Management

Supply chain management is perhaps the most common application of RFID especially in apparel. Tracking and managing the flow of goods through the supply chain is an expensive and complex procedure. So, by using RFID technology, the supply chains can save a lot of money and labor. Any item or a pallet can be tracked from manufacturers, through transportation, wholesale and retail until it is bought by a customer. This keeps track of shelf life of some perishable items which can reduce wastage due to expired or rotten items as the items with less shelf life can be sold before the ones having greater shelf life. There are many companies which are using this RFID technology like Coca-Cola, Wal-Mart, Target and Proctor & Gamble for tracking their hundreds of billions of products [10] [11] [12].

1.7.6 Manufacturing

RFID systems are used in manufacturing plants in many countries by companies like Porsche, Airbus, etc. [13] [14]. It is used to track raw material, parts and work in

progress. It reduces defects and helps in increasing the throughput of the system. It also manages the production of different versions of same products.

1.7.7 Retailing

Many companies are using RFID technology for keeping track of the products in their stores. Companies like Wal-Mart, Target, Best buy, Macy's and Tesco uses RFID to increase their store efficiency and making sure the product is on shelf when the customers want to buy it [15] [16].

1.7.8 Payment Systems

Transportation payment system is one of the very first applications of RFID which was developed in late 1980s. These are mainly used in automatic toll payment. The driver doesn't need to stop vehicle for giving the tolls. Instead, RFID tags are used which can be identified by the reader at the toll booth and later the toll amount is deducted directly from driver's account. RFID system is also used to pay for public transportation in some countries where tags are present in metro/bus cards or even in credit cards and smart cards to pay for grocery, food, laundry, etc. [17].

1.7.9 Fashion Industry

Many high-fashion brands like Swatch watches, Prada and Benetton use RFID tags for their products to keep track of their customer's movements in store as they try various clothes or other items [18]. These are even used in trying room machines where they can tell which item will match with the selected item.

1.7.10 Access Control

As one of the older applications of RFID, access control systems provide access to buildings, offices or clubs, etc. Only the authorized personnel will have that access and privacy can be maintained using these access control cards with RFID tags.

1.7.11 Entertainment Industry

RFID tags are also being used in entertainment industries like Disney theme parks [19]. They are using tags in their bands to keep track of their customers and give them access to various rides, or as room keys for customers staying at Disney resorts.



Figure 1.7: Disney's RFID band

CHAPTER 2: REVIEW OF ANTI-COLLISION ALGORITHMS FOR PASSIVE RFID SYSTEMS

RFID systems are classified as passive if they are using passive tags for communication as described in the previous section by harvesting radio frequency waves in the environment generated by the reader antenna. In a passive RFID system, when the reader sends a query command to the tags, tags respond to the reader on a random basis. But in an environment with large number of tags, it is possible that few tags responds to reader's query command at the same time. So, when two or more tags respond to reader's query command at the same time, it is known as a collision. This is one of the major issues in RFID technology as it results in wasted bandwidth, energy and increases identification delays. To minimize collisions, RFID readers implement some form of an anti-collision protocol. There are numerous anti-collision algorithms proposed in the literature to reduce or avoid this collision problem. In this chapter, we will review majority of the important anti-collision protocols and compare characteristically different approaches.

2.1 Classification of RFID Anti-Collision Protocols

RFID anti-collision protocols can generally be categorized as shown in figure 2.1 [20] [21].

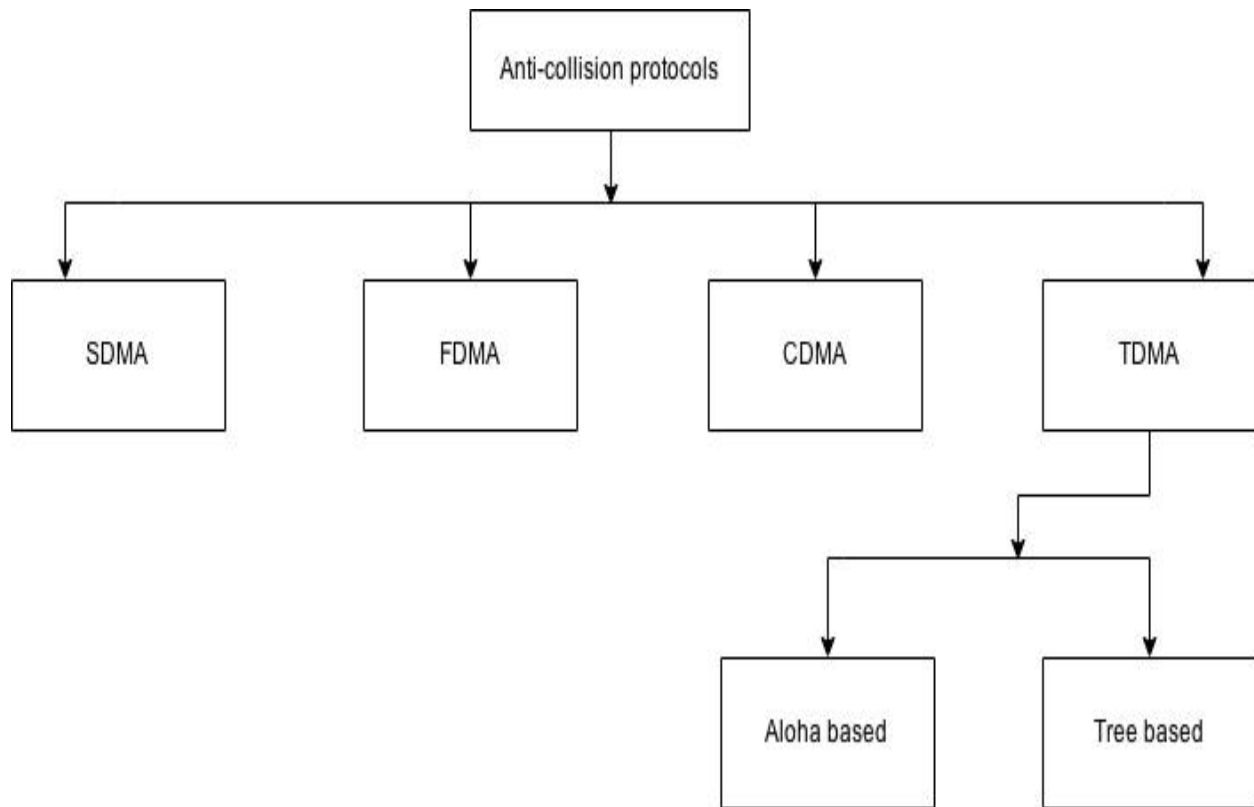

Figure 2.1: Classification of RFID anti-collision protocols

2.1.1 Space Division Multiple Access (SDMA) Protocols

SDMA protocols are used to divide the available channel into separate areas spatially by either using directional antennas or multiple readers. It minimizes the reading range of readers and forms an array in space. Because of its requirements for dividing space, these are expensive, complicated and requires intricate antenna designs.

2.1.2 Frequency Division Multiple Access (FDMA) Protocols

FDMA protocols divide the channel bandwidth into several smaller bandwidths. Each bandwidth is dedicated to individual tags and is used by that particular tag until the communication between tag and reader is completed. This frequency division requires a

complex receiver at the reader end for successful communication. Next chapter explores a basic scenario where a two-fold frequency division is used in conjunction with existing anti-collision algorithms in time-domain.

2.1.3 Code Division Multiple Access (CDMA) Protocols

In CDMA protocols, tags are required to multiply a pseudo-random sequence with their ID before transmitting it to the reader. Reader has a unique code to extract ID from the received signal. This system is very complicated, as it requires a lot of computational time both in tags as well as readers. This makes these protocols expensive and requires a large amount of power, which can cause issues with low-power systems such as passive RFID.

2.1.4 Time Division Multiple Access (TDMA) Protocols

TDMA protocols divide the channel bandwidth in time slots to be used by the reader and tags. There are two types of TDMA protocols.

2.1.4.1 Reader Driven Protocols

This is also known as Reader Talk First (RTF). In this protocol, tags remain silent until commanded by the reader. Most of the applications, such as passive RFID, use RTF protocols. This is further classified into aloha and tree based protocols.

2.1.4.2 Tag Driven Protocols

This is also known as Tag Talk First (TTF). In this protocol, tag announces itself by transmitting its ID to the reader. This protocol is slower as compared to RTF protocol

and is mostly preferred by active systems where tags can beacon their information to the reader.

2.2 Aloha Based Protocols

2.2.1 Pure Aloha (PA)

Aloha system was first introduced for traffic in communication networks [22]. In pure aloha or basic aloha protocol for RFID, reader sends out query command to energize tags. After being energized, tag responds with its ID randomly. It then waits for the reader to reply. If they get a positive acknowledgment (ACK) that indicates it was a successful communication and tag's ID has been received correctly. If they receive a negative acknowledgment (NACK) that indicates a collision has occurred resulting in unsuccessful communication. In case of collision, tags back off for a random time and transmit again after waiting for that amount of time.

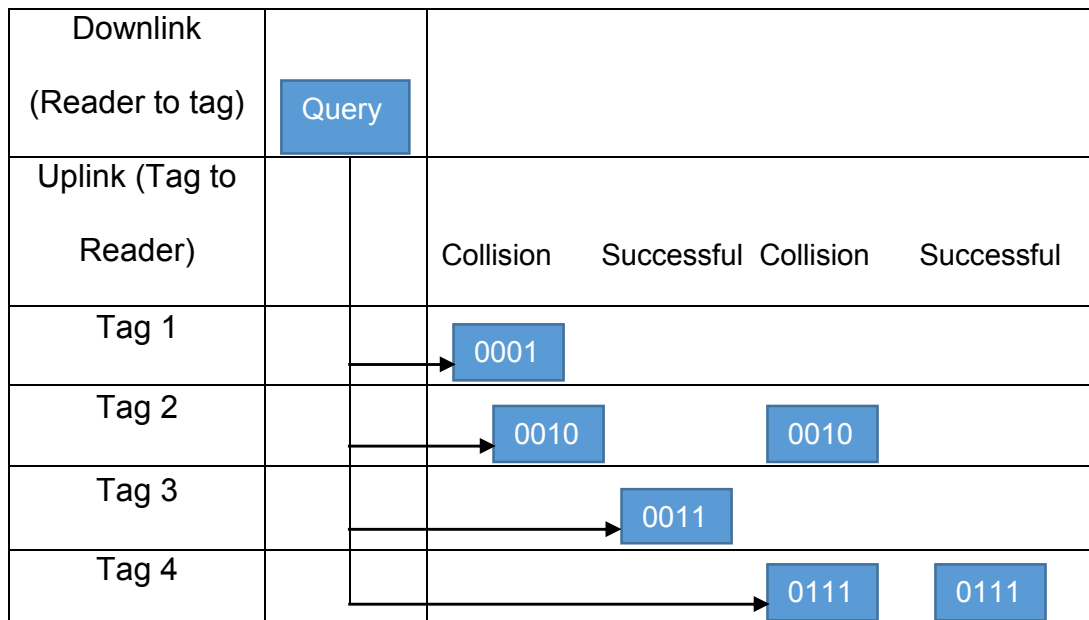

Figure 2.2: Example of working of pure aloha

In the example shown in figure 2.2, working of pure aloha protocol is explained. If there are four tags in reader's range, all will respond to reader's query at random times. Tag 1 and tag 2 collide and back off for random time. Tag 3 is read successfully. There is collision again for tag 2 and tag 4, which wait for another random amount of time. Tag 4 transmits again and is successfully read.

Pure aloha based systems have several variants [21] [23] [24].

2.2.1.1 Pure Aloha with Muting

In this protocol, after a tag is identified, reader uses "mute" command to avoid reading it again and reduce collisions. It reduces the offered load to the reader after each successful identification.

2.2.1.2 Pure Aloha with Slow Down

Pure aloha protocol with slow down instructs a read tag to reduce its transmission rate using a "slow down" command. This will decrease the probability of collision among tags when they respond to reader's signal. This will give more time to identify unread tags and reduce number of collisions.

2.2.1.3 Pure Aloha with Fast Mode

In pure aloha with fast mode, the reader sends a "silence" command once it detects the start of a tag transmission. This command stops the transmission from other tags. Once the reader send ACK command or their defined waiting time expires, tags are allowed to transmit again.

2.2.1.4 Pure Aloha with Fast Mode and Muting

This combines the features of pure aloha with muting and pure aloha with fast mode. In this, all tags except the one transmitting are silenced. Once the transmission is over and tag is read, it is muted and others are allowed to transmit again.

2.2.1.5 Pure Aloha with Fast Mode and Slow Down

In this protocol, a tag is identified using fast mode that is silencing other tags when a tag starts transmitting and then the read tag is slowed down allowing other tags to transmit and reducing number of collisions.

2.2.2 Slotted Aloha (SA)

In slotted aloha protocol, after the reader sends the query signal, tags transmit their ID in synchronous time slots. If two or more tags transmit their ID in the same time slot, it results in collision. In that case, tags wait for a random amount of time and retransmit after that random delay.

In slotted aloha example shown in figure 2.3, the reader sends query command to all the four tags present in its reading range. On receiving the query command, tags send out their ID in random slots. Tags 1 and 3 collide in the first slot, so they wait for a random amount of delay before retransmitting their IDs. Tags 2 and 3 were read successfully in slot 2 and slot 3, respectively. Slot 4 is an empty slot as no tag transmits in that slot.

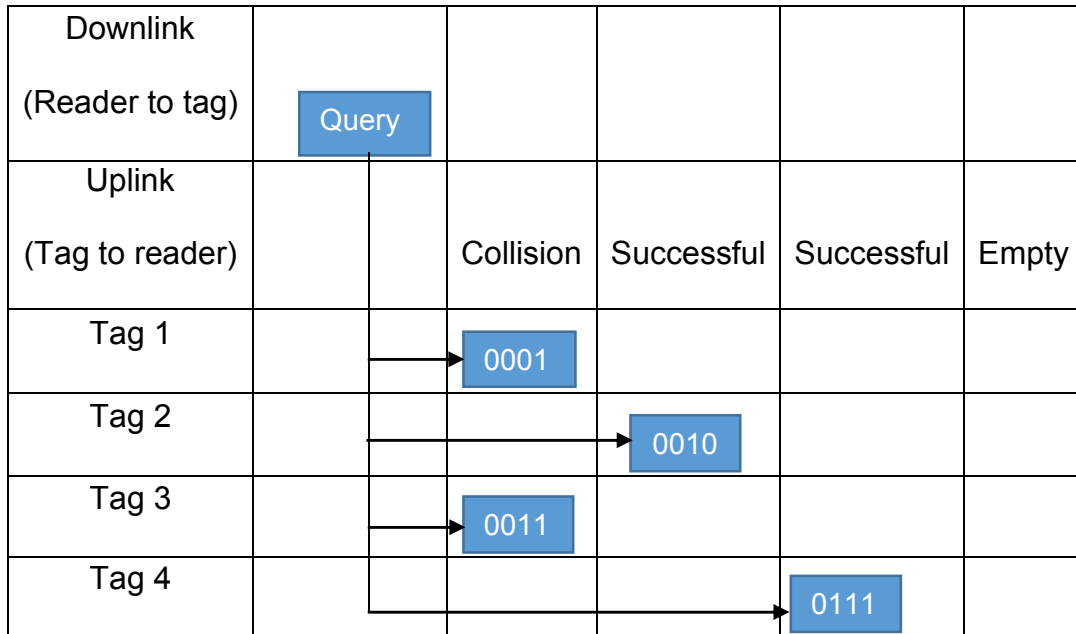

Figure 2.3: Example of working of slotted aloha

Similar to pure aloha, slotted aloha also has numerous variants [21] [23] [24].

2.2.2.1 Slotted Aloha with Muting or Slow Down

The principle operation of slotted aloha with muting/slow down is similar to pure aloha with muting or slow down except that tags respond in slots. When a tag starts transmitting, other tags are slowed down and when a tag is read, it is muted.

2.2.2.2 Slotted Aloha with Early End

In slotted aloha with early end, the reader closes the slot early if there is no transmission detected at the beginning of a slot. There are two commands used in this protocol: start-of-frame (SOF) and end-of frame (EOF). The SOF is used to start a reading cycle, and the EOF is used by the reader to close an idle slot early.

2.2.2.3 Slotted Aloha with Early End and Muting

In slotted aloha with early end and muting, features of both protocols are combined in one. When a tag is identified successfully, the reader sends a mute command to the tag. This reduces the number of responding tags. Also, if there is no transmission detected after a small period of time, it closes the slot early using the EOF command.

2.2.2.4 Slotted Aloha with Slow Down and Early End

This protocol combines the slow down with the early end feature. The reader sends slow down command to tag after it is identified so that other tags can transmit. It also ends a slot early if there is no transmission detected.

2.2.3 Framed Slotted Aloha (FSA)

Framed slotted aloha protocols are widely used anti-collision protocols for passive RFID systems. In this protocol, time is divided into frames, which are further divided into slots [25] [26]. In identification process, the reader sends the frame length in its query command to the tags. Every tag in the reading range selects its slot randomly to transmit to the reader. Each tag can respond only one time in a frame. If there is a collision, collided tags have to wait for another frame to transmit to the reader.

Working of framed slotted aloha protocol can be explained using the example shown in figure 2.4. In this example, there are four tags in reader's environment. Reader sends out query command along with the frame size. Tags select their slots randomly in the frame and transmit their ID in that time slot. Tags 1 and 3 randomly transmit in first slot, hence, resulting in a collision. These tags will wait for the next frame before

retransmitting. Tags 2 and 4 are identified successfully in the next two slots. Fourth slot is an empty slot. The reader sends out another query command keeping the same frame size. This process continues until all the tags are identified.

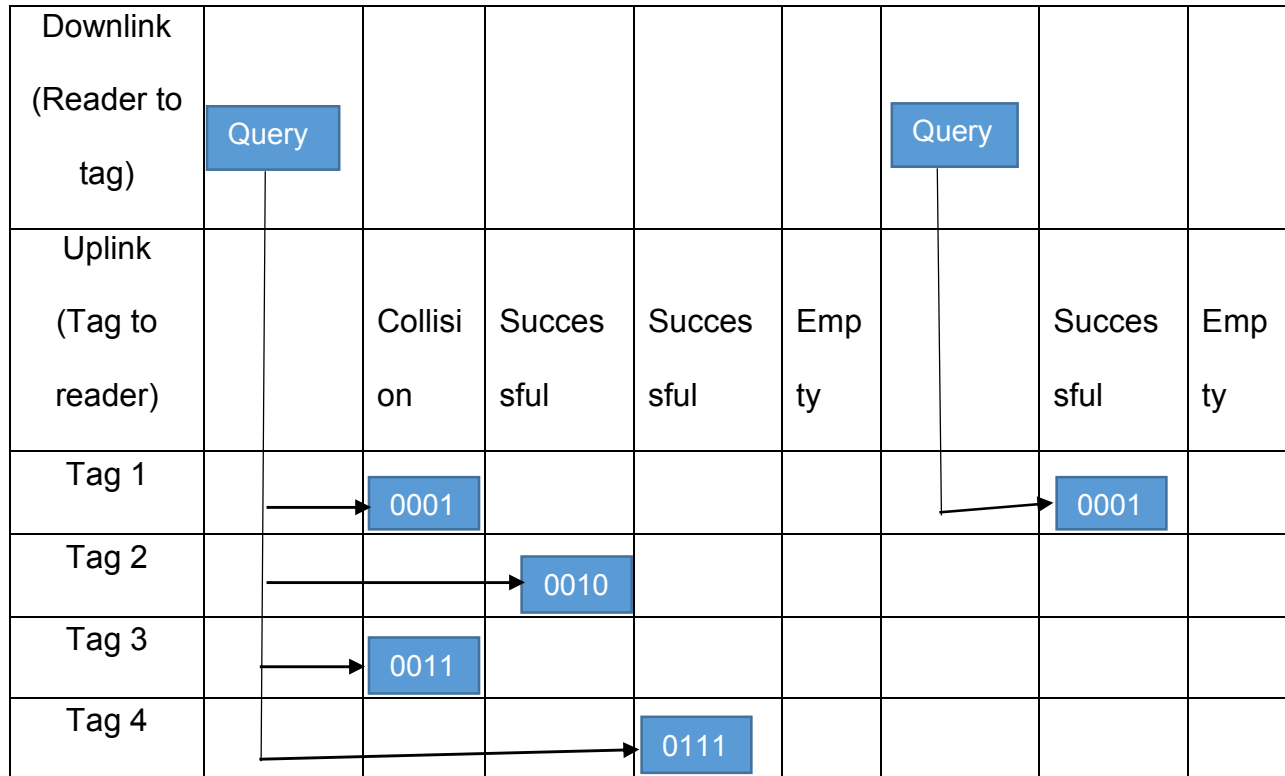

Figure 2.4: Example of working of framed slotted aloha

2.2.3.1 Basic Framed Slotted Aloha (BFSA)

In basic framed slotted aloha, the frame length is the same for all identification cycles.

2.2.3.1.1 BFSA with Non-Muting

In BFSA with non-muting protocol, each tag has to select a slot in each reading cycle and is required to transmit its ID in that slot. If the number of tags are greater than the frame size, identification delay is quite large for this protocol.

2.2.3.1.2 BFSA with Muting

In BFSA with muting protocol, the tags are silenced after identification, hence, reducing the number of tags after each read round.

2.2.3.1.3 BFSA with Non-Muting and Early End

This protocol incorporates the early end feature in BFSA with non-muting protocol.

2.2.3.1.4 BFSA with Muting and Early End

Early end feature is added to BFSA with muting protocol.

2.2.3.2 Dynamic Framed Slotted Aloha (DFSA)

When the number of tags exceeds frame size, the throughput of the system decreases as there are more number of collisions and identification delays are significant. To overcome this problem, the reader uses tag estimation function to estimate the number of tags present in the reading range. This estimation is then used to vary frame size in each reading cycle [27]. There is a limitation on frame size in DFSA. It cannot exceed a value of 256.

2.2.3.3 Enhanced Dynamic Framed Slotted Aloha (EDFSA)

In order to overcome the frame size limitation of DFSA, tags are divided into M groups if the tag population is larger than the maximum frame size [28]. This is done by estimating the number of tags, comparing it with the frame size and then, calculating how many groups are required. Tags are, then, divided into calculated M groups. On receiving the reader's query, first group of tags responds and this whole procedure is repeated for every frame.

The following table shows the comparison between different kinds of aloha based protocols and their reported average efficiencies in the literature.

Table 2.1: Comparison of aloha based protocols

Criterion	Pure Aloha	Slotted Aloha (SA)	Basic Framed Slotted Aloha (BFSA)	Dynamic Framed Slotted Aloha (DFSA)	Enhanced Dynamic Framed Slotted Aloha (EDFSA)
Protocol Feature	Tag transmits its ID after a random time to the reader. In case of collision, it will retransmit after a random delay.	Tags transmit their ID in synchronized slots. In case of collision, tag will respond after a random number of slots.	Tag can transmit only one time in a fixed frame.	Tag can transmit only once per frame, and the frame size varies according to tag population.	Tags are divided into groups if the number of tags are greater than the maximum frame size.
Throughput	18.4%	36.8%	36.8%	42.6%	36.8%

2.3 Tree Based Protocols

There is another set of protocols known as tree based protocols, which are used for solving the same collision problem. These protocols single out each tag with a unique ID and identify them. All tree-based protocols have muting capability which means tags are silenced after their identification. Following table gives the description and comparison of various existing tree-based protocols [29] [30].

Table 2.2: Comparison of tree based protocols

Criterion	Query Tree (QT)	Tree Splitting (TS)	Binary Search (BS)	Bitwise Arbitration (BTA)
Protocol feature	The reader transmits a query, and tags with prefix matching the query respond.	Collision is resolved by splitting collided tags into disjoint subsets.	The reader sends a serial number and those with values less than or equal to the serial number reply.	Each tag responds in a bit by bit manner.

The following table gives the comparison between aloha based and tree based algorithm.

Table 2.3: Comparison between aloha based and tree based protocols

Criterion	Aloha protocols	Tree protocols
Protocol feature	They require tags to respond randomly in an asynchronous manner or in synchronized slots or frames.	They operate by grouping responding tags into subsets and then identifying tags in each subset sequentially.
Delays versus tag density	Low identification delays achievable only when tag density is low.	Low identification delays in high tag density environments.
Method	Probabilistic	Deterministic
Optimum Channel Utilization	18.4% (Pure Aloha), 36.8% (BFSA), 42.6% (DFSA)	43%

2.4 RFID Anti-Collision Standards

There are two main bodies, which are responsible for RFID standards: international organization for standardization (ISO) and EPCglobal. ISO mainly defines the air interface specifications for various RFID applications whereas EPCglobal defines

industry-driven standards for product tracking in supply chains internationally. Some of these standards and their anti-collision protocols are listed below.

Table 2.4: ISO standards [21] [24] [31]

Standard	Frequency	Protocol used
ISO 18000-3 "MODE 1"	HF	Pure aloha and dynamic framed slotted aloha
ISO 18000-3 "MODE 2"	HF	Combination of TDMA and FDMA
ISO 14443-3 Type-A	HF	Dynamic slotted aloha
ISO 14443-3 Type-B	HF	Dynamic framed slotted aloha
ISO-18000-6A	UHF	Framed slotted aloha with muting and early-end
ISO-18000-6B	UHF	Tree based protocol

Table 2.5: EPCglobal standards [21] [32] [33]

Standard	Frequency	Protocol used
EPCglobal Class 0	UHF	Tree based protocol
EPCglobal Class 1	UHF	Tree based protocol
EPCglobal Class 1 Gen 2	UHF	Q-Algorithm
EPCglobal Class 1	HF	Framed slotted aloha with early-end

In this study we mainly focus on EPCglobal Class 1 Gen 2 protocol. In this standard [33], Q-Algorithm is used for solving the collision problem where the value of Q can be dynamically adjusted based on collisions and idle frames which would change the frame size as frame size is determined by 2^Q . A more detailed description of the Q-algorithm is provided in Chapter 4.

CHAPTER 3: EFFECTS OF 2-FOLD FREQUENCY DIVISION APPROACH ON EXISTING ANTI-COLLISION ALGORITHMS

3.1 2-Fold Frequency Division Approach

Tag collision is a major problem in implementing RFID where large number of tags are involved. After studying all the major anti-collision protocols, we wanted to explore the impact of a simple 2-fold frequency division on two of the anti-collision algorithms. Our goal is to divide the operating UHF frequency range of 902-928MHz into two equal parts: 902-914 MHz and 915-928MHz. In our calculations of system efficiency, we assumed that the tags in the reader's field are equally divided into these two frequency ranges. This is a statistically reasonable assumption especially considering large populations of tags as in this study. We also assumed no disruptive interference in the 902-928MHz band which could reduce performance in a frequency-hopping communication channel like passive RFID systems when frequency hops are limited only to the bandwidth where there is significant interference.

There are several ways to implement frequency division. One method is to design more selective antennas and manufacture tags accordingly. In this study, we concentrated on using simple low-pass and high-pass filters, which effectively divide the frequency range into two and can be implemented on semi-passive RFID tag hardware. Tags with low pass filters are tuned to the lower frequency range and operate at an approximate

frequency range of 902 MHz to 914 MHz whereas tags with high pass filters are tuned to the higher frequency range and operate at an approximate frequency range of 915 MHz to 928 MHz. The components of these filters are chosen carefully for plausible implementation on printable semi-passive RFID tags such as resistors, capacitors and operational amplifier.

3.2 Filters

Filters are circuits, which perform signal processing functions to remove the unwanted parts of the signal and to modify the signal as per the requirements of the application. These filters can be categorized by various aspects.

- Active and Passive filters

Passive filters are made up of passive components like resistors, capacitors and inductors whereas active filters have active components like operational amplifiers along with passive components resistors and capacitors. Passive filters do not have a power gain while active filters have a power gain which allows them to amplify the output signal.

- High Pass, Low pass and Band pass filters

- High Pass Filters allow the circuit to pass only the frequencies from its cut off frequency to infinity.
- Low pass filters allow the circuit to pass only the low frequency signals from DC up to its cut off frequency.
- Band pass filters allow the circuit to pass only the parts of the input signal with frequency content between the two cut-off frequencies.

The low pass and high pass filters which we designed for limiting the frequency range for the tags to communicate with the reader is explained in following sub-sections.

3.2.1 Low Pass Filter

With the addition of the low-pass filter, the tag is able to communicate with the reader only in the frequency range of 902 MHz to 914 MHz. Hence, the low pass filter is designed in a way to have a cut-off frequency, f_c equal to 914 MHz.

Following figure 3.1 shows the circuit diagram for the chosen low pass filter.

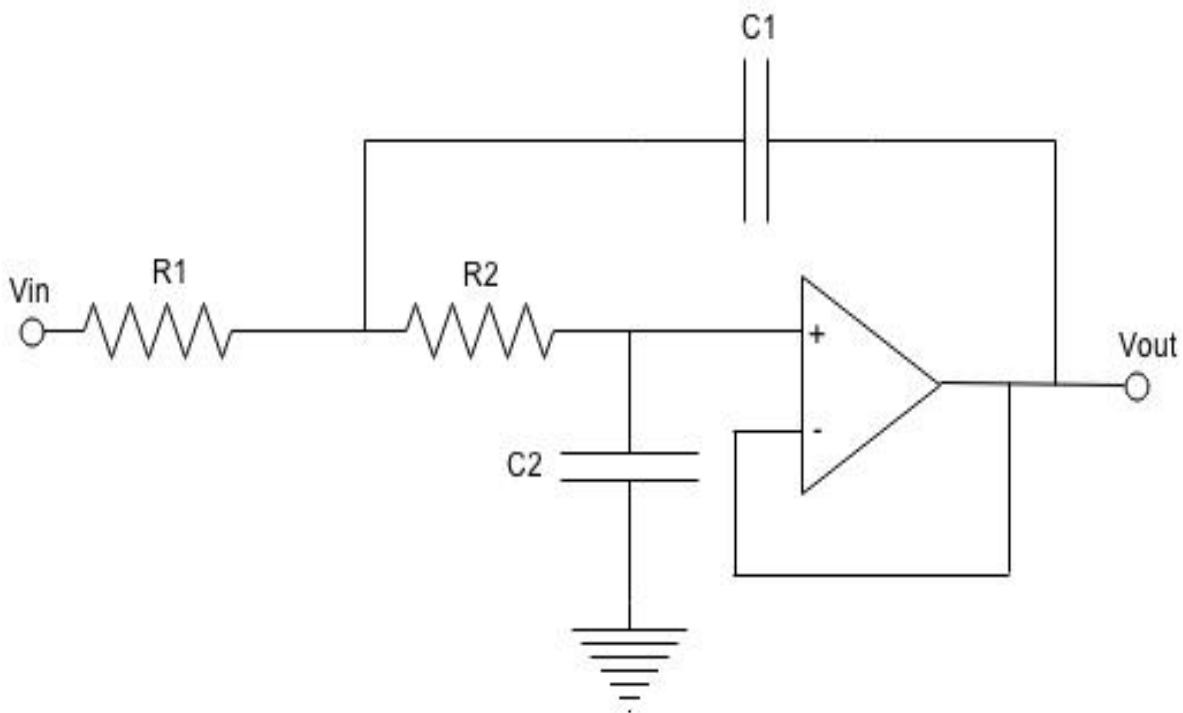

Figure 3.1: Circuit diagram of low pass filter

Based on this filter design, the cut-off frequency can be calculated as follows.

$$f_c = \frac{1}{2\pi\sqrt{R_1 C_1 R_2 C_2}} \quad (1)$$

where f_c = Cut-off frequency of the filter

R_1, R_2 = Resistors in the filter

C_1, C_2 = Capacitor in the filter

The figure below shows the magnitude and phase response of a low-pass filter which satisfies the requirements.

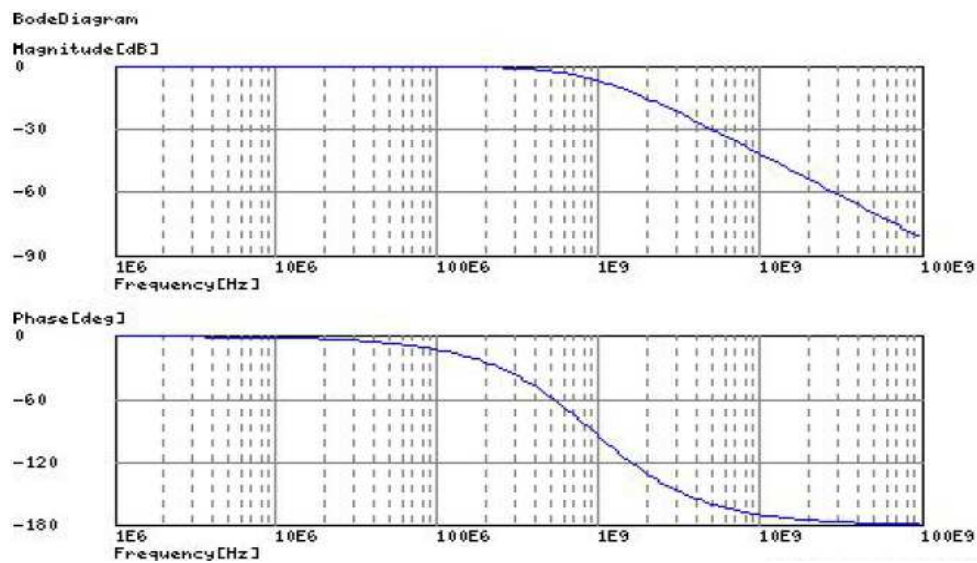

Figure 3.2: Frequency response of low pass filter

In order to obtain the response plots in figure 3.2, we have chosen the values of the resistors to be equal and 174 Ω . Similarly the values of capacitors were taken as 1pF for getting a calculated cut off frequency as 914.68 MHz. The values of the components were chosen carefully to be in line with existing resistor and capacitor components on RFID tags. Hence, $R_1 = R_2 = 174\Omega$ and $C_1 = C_2 = 1\text{pF}$. Using formula (1), we have,

$$\text{Cutoff frequency, } f_c = 914.68\text{MHz}$$

This means that when a reader uses a hopping frequency between 902 and 914MHz, only the tags embedded with the low-pass filter will reply.

3.2.2 High Pass Filter

Contrary to the low-pass filter, the high-pass filter will enable the tag to communicate with the reader only in the frequency range 915 MHz to 928 MHz. Hence, the high pass filter is designed in a way to have a cut off frequency, f_c equal to 915 MHz.

Following figure 3.3 shows the circuit diagram for a high pass filter, which can be used in tags to filter the higher frequencies.

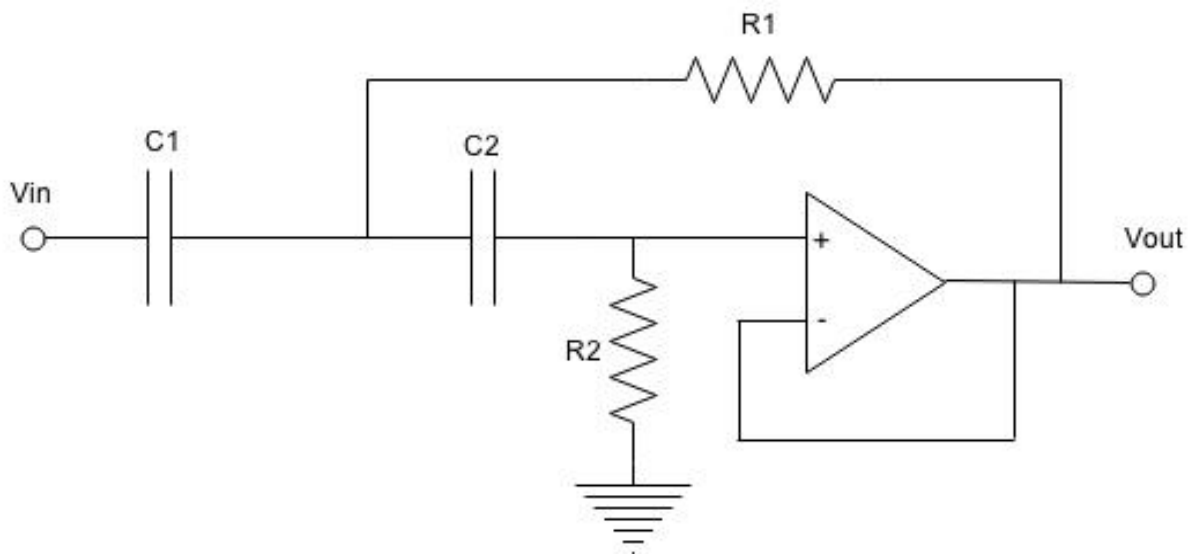

Figure 3.3: Circuit diagram of high pass filter

Based on this filter design, the cut off frequency can be calculated as follows.

$$f_c = \frac{1}{2\pi\sqrt{R_1 C_1 R_2 C_2}} \quad (2)$$

where f_c = Cut off frequency of the filter

R_1, R_2 = Resistors in the filter

C_1, C_2 = Capacitor in the filter

The figure below shows the magnitude and phase response of a high-pass filter which satisfies the requirements.

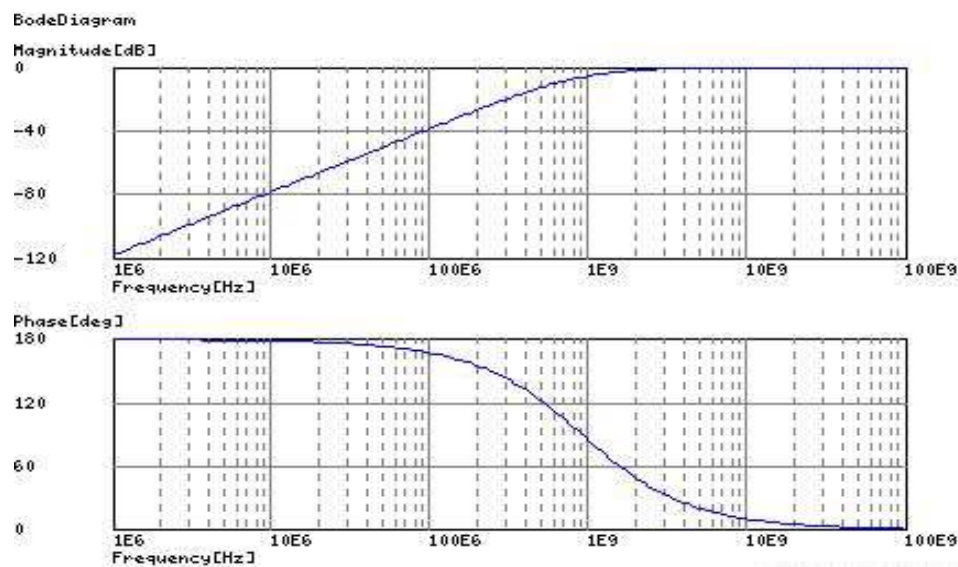

Figure 3.4: Frequency response of high pass filter

Just like the low-pass filter, the values of resistors are equal and can be taken as 174Ω . Similarly the values of capacitors are taken as 1pF for getting the cut off frequency as 914.68 MHz . That is, $R_1 = R_2 = 174\Omega$ and $C_1 = C_2 = 1\text{pF}$. Using formula (2), we have,

$$\text{Cutoff frequency, } f_c = 914.68\text{MHz}$$

This means that when a reader uses a hopping frequency between 915 and 928MHz , only the tags embedded with the high-pass filter will reply.

3.3 Performance Comparison of Select State-of-the-Art Protocols using 2-Fold Frequency Division

In this section, we will explore the effect of using 2-fold frequency division approach with two existing anti-collision algorithms – the standard aloha technique and an advanced reservation based aloha technique with superior efficiency. We investigate the maximum theoretically possible improvement in efficiency for both algorithms.

- We assume no disruptive interference in the environment.
- We assume tags are at equidistance from the reader, which eliminates the effects of distance around the cut-off region for both types of tags.

3.3.1 Framed Slotted Aloha Protocol

In the framed slotted aloha, tags responds to reader's query in the chosen time slot of the frame whose size is defined in the reader's query. Here, we calculate system efficiency of framed slotted aloha protocol and see how it changes when we use 2-fold frequency division approach.

When the number of tags to be read are n and frame size used by reader is N , the probability of r tags to choose the same slot to respond to the reader is given by [28]:

$$B_{n, \frac{1}{N}}(r) = \binom{n}{r} \left(\frac{1}{N}\right) \left(1 - \frac{1}{N}\right)^{n-1} \quad (3)$$

The number of slots filled with one tag can be calculated from:

$$a_1^{N,n} = N \cdot B_{n, \frac{1}{N}}(1) = N \cdot n \left(\frac{1}{N}\right) \left(1 - \frac{1}{N}\right)^{n-1} \quad (4)$$

Therefore, the system efficiency can be calculated as:

$$\text{Efficiency} = \frac{\text{Number of slots filled with one tag}}{\text{Frame size}} = \frac{a_1^{N,n}}{N} \quad (5)$$

To compare the efficiencies, we fix the frame size (N) to be 64 and vary the number of tags (n) from 10 to 50. Using the equation (3), (4) and (5), we can calculate the system efficiency as shown in the following graph.

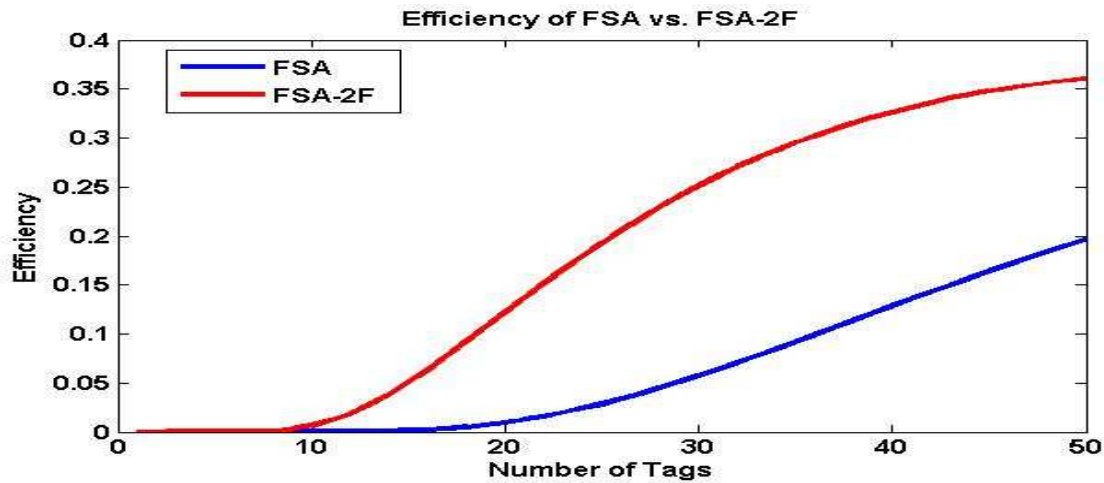

Figure 3.5: Efficiency of FSA protocol with and without 2-fold frequency division approach

As we can see in figure 3.5, the efficiency of framed slotted aloha protocol using 2-fold frequency division approach is greater than framed slotted aloha protocol. This increase, although a theoretical maximum, is quite significant and reduces the identification delays.

3.3.2 Reservation Slot with Multi-Bits Aloha Protocol

In reservation slot with multi-bits aloha (RSMBA) protocol [34], the communication is divided into two steps. First step is the reservation procedure and second step is the

identification procedure. In the reservation procedure, tags reserve their slots by sending random sequence in the reservation slot after reader's query. In the second step, the reader allocates the slots to the tags in accordance with their reservation process and allows tags to send their data on the reserved slots for identification.

For calculating the system efficiency using RSMBA protocol, we have to follow the steps below. The reader sends the query command with value of 'q' which is used to define the number of reservation slots by using $L = 2^q$. Each tag selects a random slot $s \in [0; L-1]$ and generates a v-bit random sequence.

Let probability of a tag to choose a reservation slot be p. So, we have

$$p = L^{-1} = 2^{-q} \quad (6)$$

Using this probability, we can calculate the probability when the reservation slot is selected by only one tag. The success probability is as follows.

$$P_s = \binom{n}{1} 2^{-q} \left(1 - \frac{1}{2^q}\right)^{n-1} \quad (7)$$

The expected number of successful slots which are reserved by one tag are:

$$L_{succeed} = L \times P_s = n \left(1 - \frac{1}{2^q}\right)^{n-1} \quad (8)$$

Similarly, to calculate the probability of k tags selecting the same reservation slot, we use:

$$P_k = \binom{n}{k} p^k (1 - p)^{n-k} \quad (9)$$

To calculate the probability of k tags generating the same v-bit random number for reservation is:

$$P_{ck} = P_k \times \binom{2^v}{1} \left(\frac{1}{2^v}\right)^k = \binom{n}{k} \left(\frac{1}{2^q}\right)^k \left(1 - \frac{1}{2^q}\right)^{n-k} \binom{2^v}{1} \left(\frac{1}{2^v}\right)^k \quad (10)$$

When two or more tags generate the same v-bit random number to reserve the same slot, there is a collision. The probability of collision can be calculated as:

$$P_c = \sum_{k=2}^n P_{ck} = \sum_{k=2}^n \binom{n}{k} \left(\frac{1}{2^q}\right)^k \left(1 - \frac{1}{2^q}\right)^{n-k} \binom{2^v}{1} \left(\frac{1}{2^v}\right)^k \quad (11)$$

Therefore, the expected number of slots resulting in collision will be:

$$L_{collision} = L \times P_c = 2^q \sum_{k=2}^n \binom{n}{k} \left(\frac{1}{2^q}\right)^k \left(1 - \frac{1}{2^q}\right)^{n-k} \binom{2^v}{1} \left(\frac{1}{2^v}\right)^k \quad (12)$$

There are time overheads from the reservation slots which should be considered while calculating the efficiency.

$$L_{equivalent} = \frac{L \times v}{size(ID)} = \frac{2^q \times v}{size(ID)} \quad (13)$$

where size (ID) = number of bits in ID. Here, we are taking it to be 256.

We can calculate the system efficiency by dividing the number of successful slots with total number of slots.

$$\eta(q, n, v) = \frac{L_{succeed}}{L_{collision} + L_{succeed} + L_{equivalent}} = \frac{n \left(1 - \frac{1}{2^q}\right)^{n-1}}{2^q \sum_{k=2}^n \binom{n}{k} \left(\frac{1}{2^q}\right)^k \left(1 - \frac{1}{2^q}\right)^{n-k} \binom{2^v}{1} \left(\frac{1}{2^v}\right)^k + n \left(1 - \frac{1}{2^q}\right)^{n-1} + \frac{2^q \times v}{size(ID)}} \quad (14)$$

We use equation (14) to calculate the efficiencies of RSMBA and RSMBA with 2-fold frequency division approach.

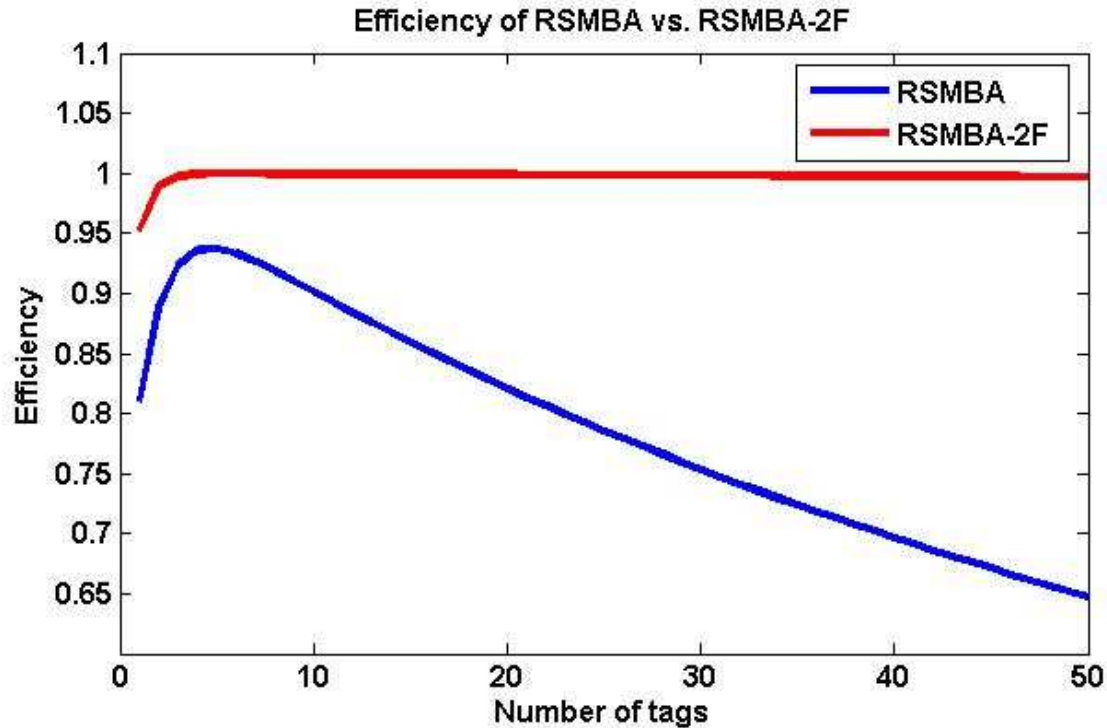

Figure 3.6: Efficiency of RSMBA protocol with and without 2-fold frequency division approach

As we can see in figure 3.6, the efficiency of RSMBA protocol using 2-fold frequency division approach is greater than RSMBA protocol. It reaches almost 99% which minimizes any chance of collision for tag numbers less than 50.

CHAPTER 4: PARAMETRIC COMPARATIVE STUDY AND DYNAMIC MODIFICATION OF GEN 2 STANDARD ANTI-COLLISION ALGORITHM

4.1 EPCglobal Class 1 Generation 2 Standard Protocol

The EPCglobal Class 1 Generation 2 (EPC C1G2) standard, commonly known as Gen 2 standard, is used worldwide for RFID systems operating in the 860 MHz – 960 MHz frequency range [33]. It defines the physical and logical requirements for a passive RFID system where reader talks first. This standard protocol uses dynamic framed slotted aloha based on Q-algorithm. According to the protocol, all tags must have a random number generator and a slot counter. The inventory operations are based on slotted aloha collision resolution. To start the inventory round, reader send a 22-bit QUERY command sending the value of Q for all tags in the environment. The value of Q parameter is an integer in the range 0 to 15 and defines the frame size as the exponential 2^Q . After receiving the query command, tags randomly select a number between 0 and 2^Q-1 and store it in their slot counters. This number represents the slot in the frame in which that tag can respond to the reader. The tag having random number 0 in its slot counter should reply immediately by issuing a 16-bit identification number (RN16) using its random number generator while other tags should decrease their counter after every slot and wait for their turn. There are three possibilities that may arise after transmitting the RN16:

1. Idle slot: If there is no reply from any tag i.e. the reader does not receive any signal before the specified time limit (T_1+T_3), the slot is considered as idle. The reader can issue another Query command or it can issue a 9-bit QueryAdjust or a 4-bit QueryRep command depending on whether the value of Q needs to be changed. QueryAdjust command increase or decrease the value of Q and change the frame size by sending out new value of Q whereas QueryRep command repeats the same value of Q and moves the counter to the next slot.
2. Successful slot: When there is only one tag replying to the reader's query command in a slot and its received ID matches the slot number, it is known as successful slot. The communication between a tag and reader can be seen in figure 4.1 for a successful slot in which a single tag responds. If a tag receives an 18-bit ACK command with the correct RN16 from the reader, it starts sending its data including the 96 or 256-bit Electronic Product Code (EPC) and 16-bit Cyclic Redundancy Check (CRC). If the received data is correct, reader replies with the QueryRep command as shown in figure 4.2. This will make the read tag to leave the identification process and will make other tags to decrease their slot counter by 1. In case of incorrect data, the reader sends 8-bit NACK command and the involved tag is not allowed to respond again in that inventory round. After this the reader may send QueryRep command for other tags.
3. Collision slot: A collision slot is when there are two or more tags responding in the same slot. When the reader identifies the collision, it issues QueryRep or QueryAdjust command as discussed above.

This procedure continues slot-by-slot until all tags are identified. Following are some figures showing the communication between tag and reader for various cases.

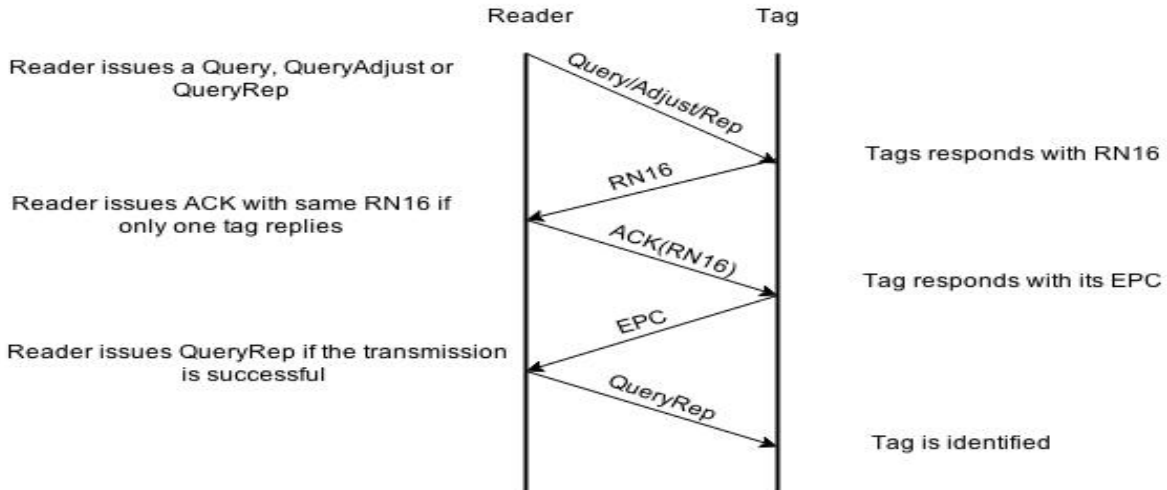

Figure 4.1: Communication between reader and tag for a successful slot

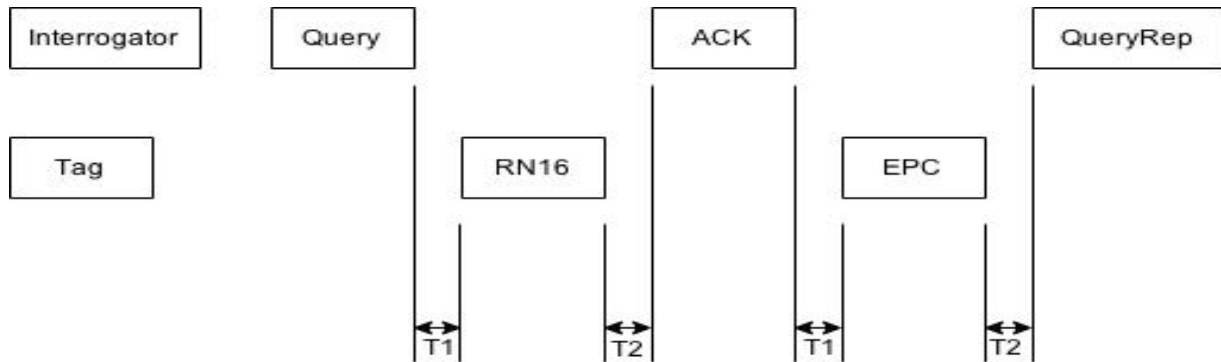

Figure 4.2: Link timing and communication for a successful slot

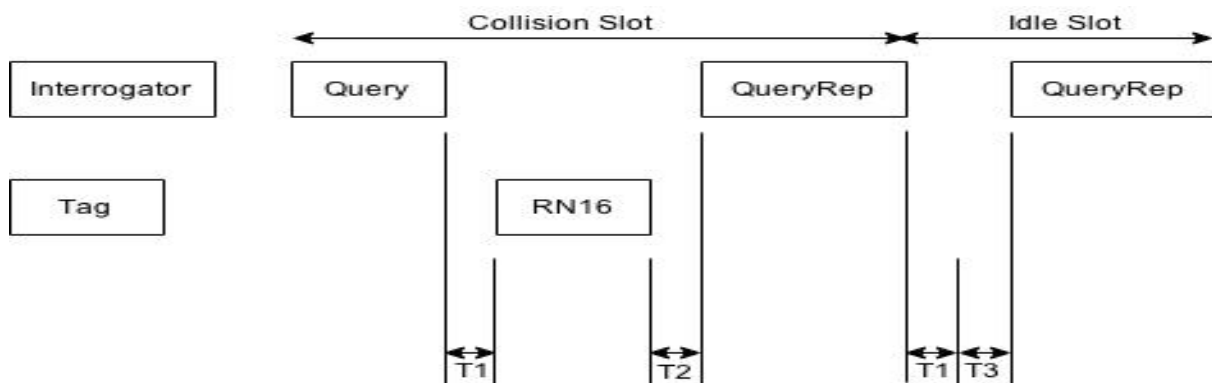

Figure 4.3: Link timing and communication for a collision and idle slot

In figure 4.2 and 4.3, there are various time parameters shown. Following is the explanation of all the time parameters used.

- T_1 : The time from the end of reader's transmission to the start of tag's response.
- T_2 : The time from the end of tag's response to the start of reader's transmission.
- T_3 : The time reader waits after T_1 before issuing another command.

The most important part of this protocol is to adjust the frame size by modifying the Q parameter. The reader can adjust Q by sending a QueryAdjust command. If the value of Q is changed, all tags will change the Q value and get a new random number. Following algorithm is used in Gen 2 standard for estimating the Q value with an initial Q value of $Q_{fp} = 4$.

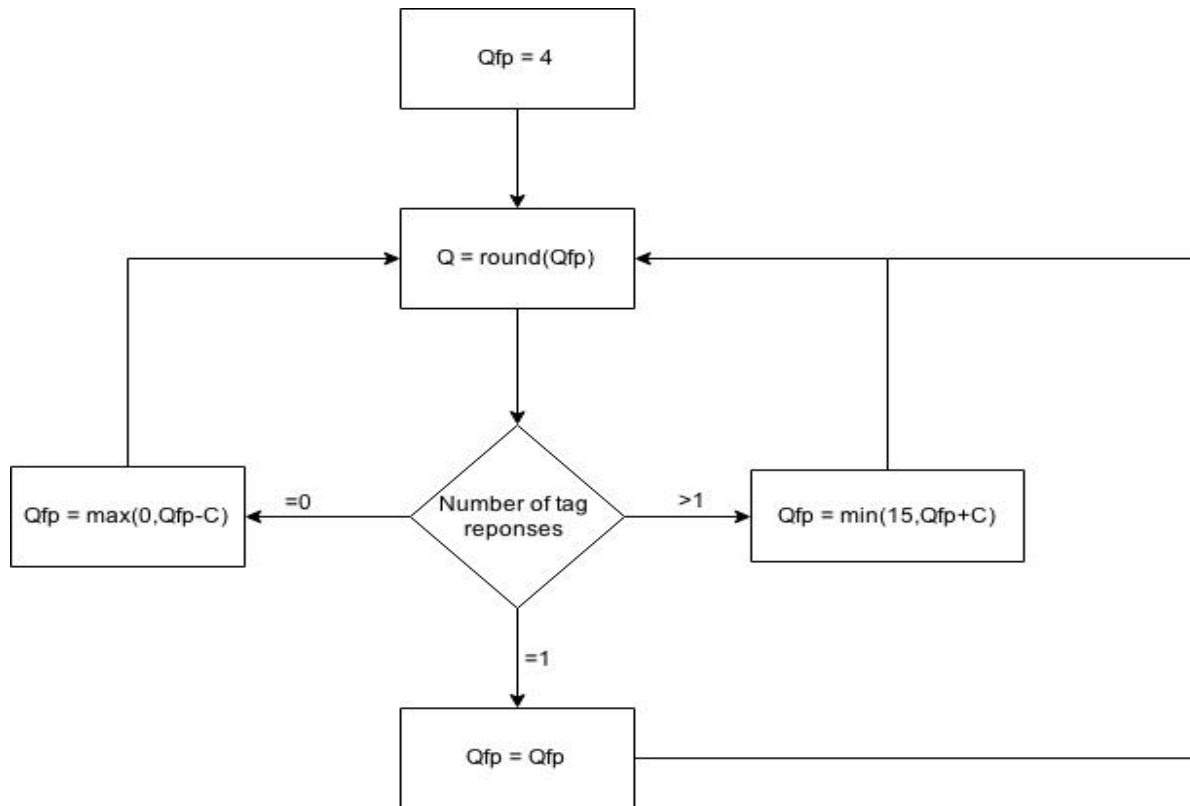

Figure 4.4: Algorithm for choosing Q parameter in Gen 2 protocol

In the algorithm shown in figure 4.4, Q_{fp} is a floating point representation of Q . The reader rounds Q_{fp} to an integer value and uses this Q value in its query command for identification process. The reader uses the variable C to vary the Q value as per the number of tags responses. This variable C can have value from 0.1 to 0.5 which is chosen a parameter of the system. The reader typically uses a large value of C when Q is small and vice versa to adjust the value of Q properly.

4.2 Proposed Algorithms

4.2.1 Q-Slot-Collision Counter (QSCC) Algorithm

In the QSCC algorithm, we only modify the existing Gen 2 protocol's Q update algorithm. The reader-tag communication will otherwise be the same per the standard protocol. As discussed before, in the Gen 2 protocol, Q is modified by a fixed parametric variable C . Here, we are modifying the value of Q using both the C parameter and the number of tags responding in a colliding frame slot. The number of colliding tags can be calculated by using various methods [35] [36]. One of the more popular ones is the Radar Cross-Section (RCS) scatter plots [36]. In an RCS scatter plot, there are 2 RCS states of each responding tag. So, if N tags are responding in a slot, there will be 2^N states in the RCS scatter plot. Using the number of tags in the colliding slot, we can modify the value of Q as described in the flowchart figure 4.5.

In the modified algorithm, instead of increasing the Q value by a small value of C , we increases it as a function of number of tags responding in the collision slot as shown in figure 4.5. So, if there are more tags colliding, it will increase the value of Q with a larger value as compared to the increase with the fixed variable C .

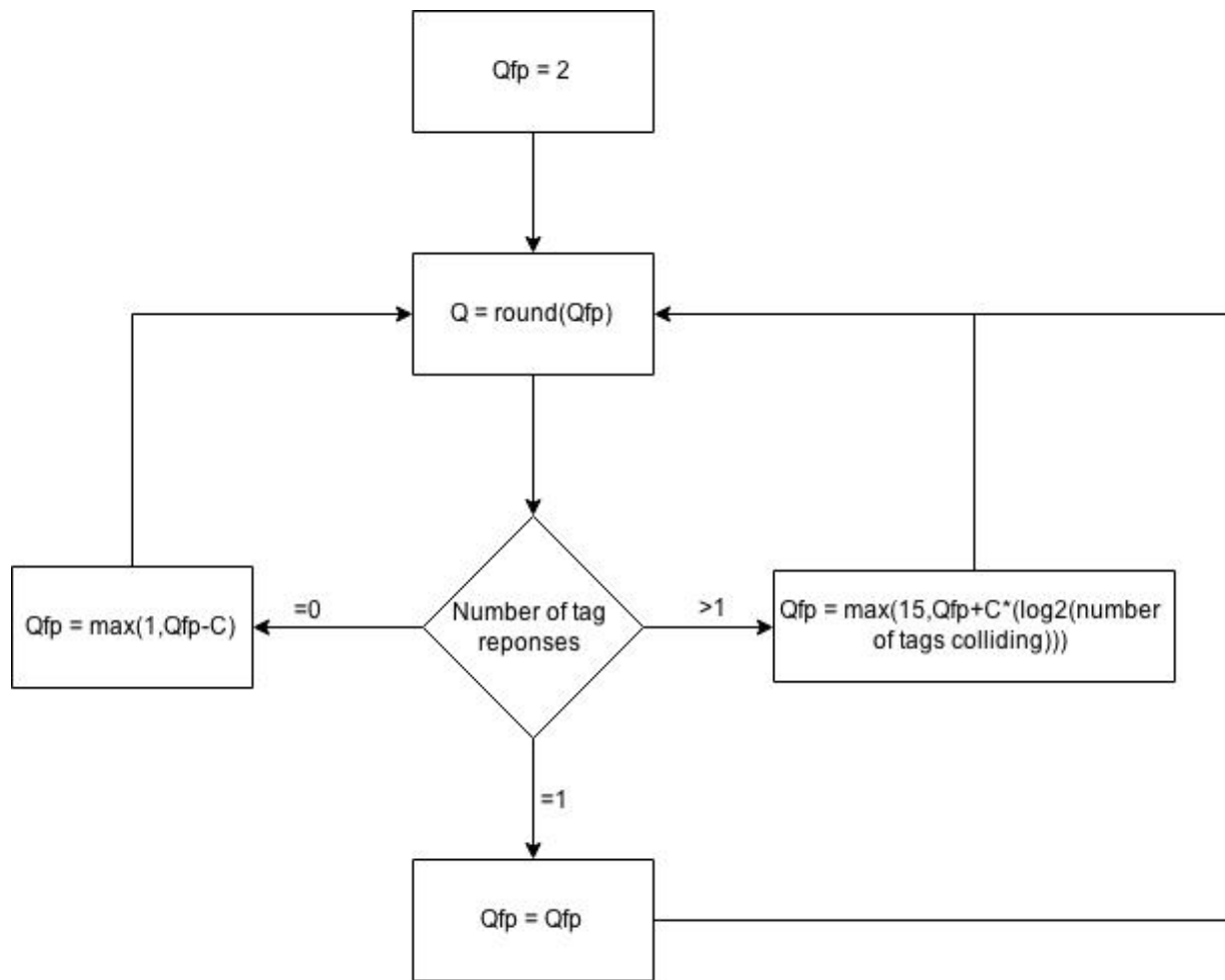

Figure 4.5: Algorithm for choosing the value of Q parameter in QSCC algorithm

4.2.2 Q-Frame-Collision Counter (QFCC) Algorithm

QFCC algorithm is another modification to the Gen 2 protocol for modifying the Q value based on the number of tags colliding in an entire frame. Compared to the standard protocol and QSCC algorithm, the value of Q parameter is independent of variable C in the QFCC algorithm. Also, the value of Q parameter is modified at the end of each frame instead of after each slot as done in the standard Gen 2 and QSCC algorithm. The Q parameter value is modified using number of collisions in a frame. In QFCC algorithm, when a frame ends, the total number of tags colliding each slot are added to

keep a running counter of the total collisions in the frame. The logarithm of this sum is used for modifying the Q value. The procedure of modifying the value of Q parameter can be seen in flowchart figure 4.6.

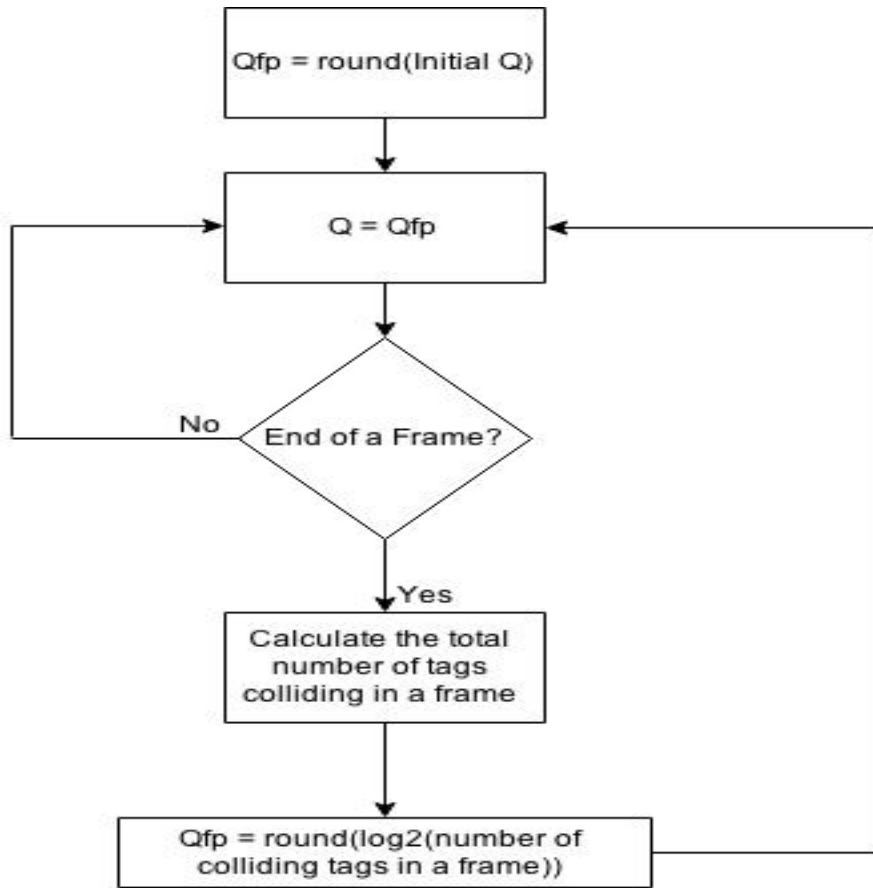

Figure 4.6: Algorithm for choosing the value of Q parameter in QFCC algorithm

4.3 Performance Evaluation

For evaluating the effect of our modifications, we used a simulation tool in Matlab designed for the existing standard protocol [37] and made the necessary modifications to simulate QSCC and QFCC. These simulations were done for two sets of number of tags: 1. Number of tags (N) = 10 to 100, and 2. Number of tags (N) = 100 to 1000 to simulate low and high density tag situations. Each simulation was run 100 times for

more reliable and consistent results. For comparing the algorithms, we calculated the efficiency for each algorithm. The efficiency here is defined in terms of the number of tags and number of time slots as follows:

$$Efficiency = \frac{Number\ of\ tags\ for\ identification}{Total\ number\ of\ slots\ used\ for\ identifying\ all\ the\ tags} \quad (15)$$

4.3.1 Performance Analysis of QSCC Algorithm

We analyzed different cases for comparing Gen 2 protocol and QSCC algorithm by taking the initial Q value as 2, 4 and 8 and initial C value ranging from 0.1 to 0.5 as defined in the standard protocol. For comparing the two algorithms, we calculate the efficiency using formula (15) for all different combination of values of C (0.1 to 0.5) and Q (2, 4 and 8). Table 4.1 and 4.2 show the mean efficiency for standard Gen 2 and QSCC for different Q values averaged across all trials and all different C values. These tables also show the maximum and minimum efficiencies obtained during simulation and the standard deviation for all trials for both set of tags.

Table 4.1: Different efficiency values for number of tags, N=10 to 100

Variation	Mean Efficiency	Maximum Efficiency	Minimum Efficiency	Standard Deviation
For Q = 2				
Gen 2	0.329658	0.341478	0.304571	0.013385
QSCC	0.342047	0.348861	0.326348	0.011084
For Q = 4				
Gen 2	0.345125	0.349591	0.33557	0.012698
QSCC	0.328335	0.337382	0.30277	0.030742
For Q = 8				
Gen 2	0.327785	0.335684	0.30409	0.031201
QSCC	0.328019	0.337706	0.304122	0.030805

Table 4.2: Different efficiency values for number of tags, N =100 to 1000

Variation	Mean Efficiency	Maximum Efficiency	Minimum Efficiency	Standard Deviation
For Q = 2				
Gen 2	0.33453	0.338515	0.330285	0.003369
QSCC	0.341756	0.346251	0.335215	0.002623
For Q = 4				
Gen 2	0.337791	0.341698	0.332053	0.002358
QSCC	0.342202	0.347373	0.334566	0.001549
For Q = 8				
Gen 2	0.341889	0.348649	0.333871	0.002141
QSCC	0.343671	0.35025	0.335249	0.002029

As we can see, there is a slight increase in the mean, maximum and minimum efficiency values of QSCC algorithm compared to Gen 2. The slightly decreased value of standard deviation for QSCC algorithm also shows the increase in robustness as the C adjustment is no longer fixed and depends on the number of collisions.

4.3.2 Performance Analysis of QFCC Algorithm

Next, performance of QFCC algorithm is compared to standard Gen 2 protocol. We calculate the efficiencies using formula (15) for C = 0.1 to 0.5 for all Q values (2, 4 and 8) for the standard protocol and compare its statistics with the simulated efficiencies of QFCC algorithm using same Q values. Following graphs show the efficiency improvement of QFCC algorithm over Gen 2 protocol for different number of tags and different values of Q.

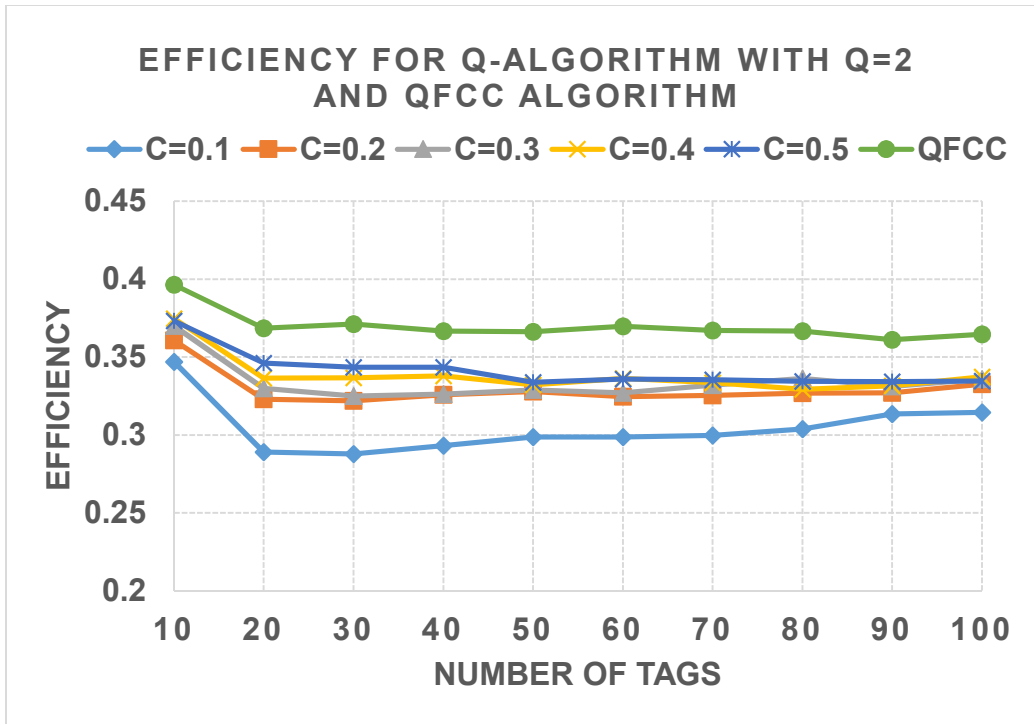

Figure 4.7: Efficiency for Gen 2 and QFCC algorithm for Q = 2 and N = 10 to 100

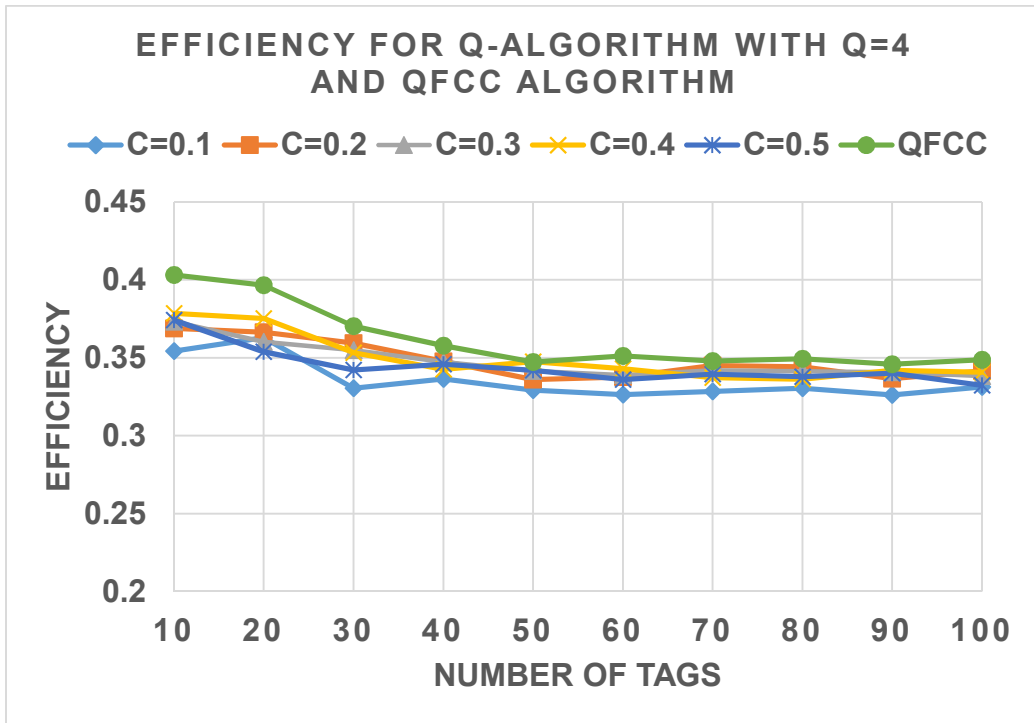

Figure 4.8: Efficiency for Gen 2 and QFCC algorithm for Q = 4 and N = 10 to 100

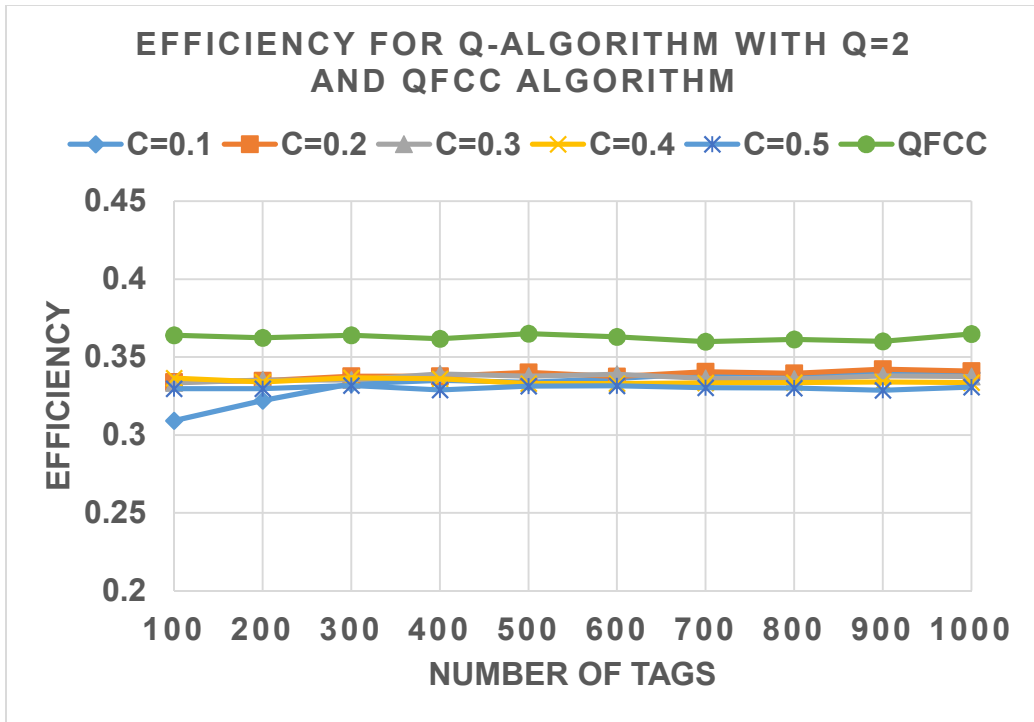

Figure 4.9: Efficiency for Gen 2 and QFCC algorithm for Q = 2 and N = 100 to 1000

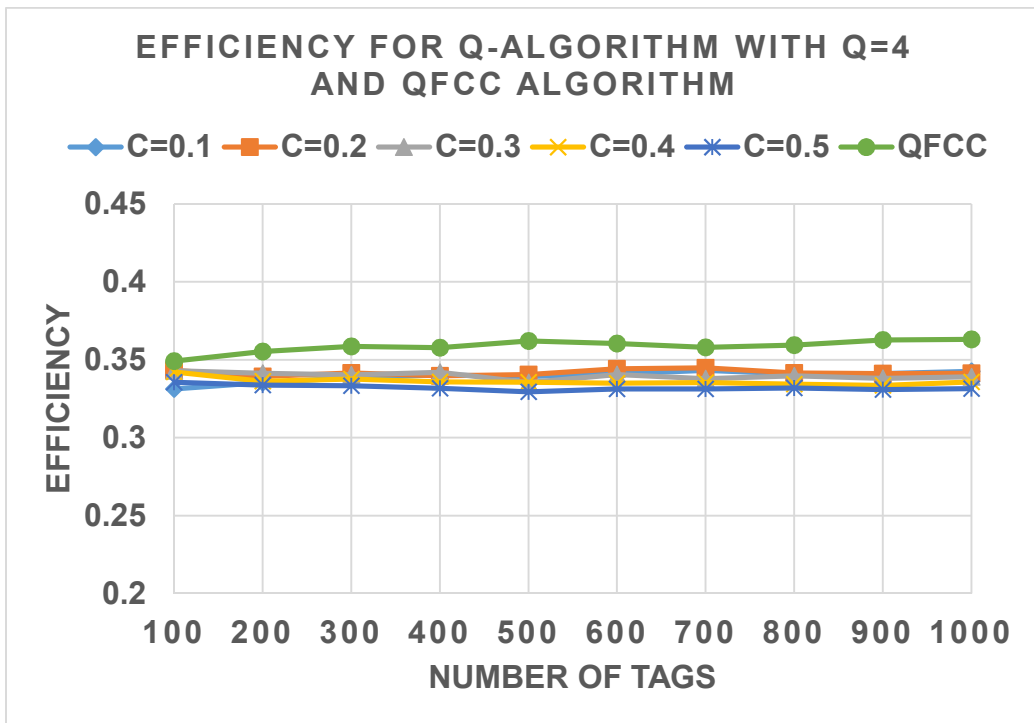

Figure 4.10: Efficiency for Gen 2 and QFCC algorithm for Q = 4 and N = 100 to 1000

As seen from the above graphs, the efficiency of QFCC algorithm is always higher than the standard Gen 2 regardless of the value of C. There is more improvement in efficiency for dense number of tags (N = 100 to 1000) which shows that it is always more efficient to use QFCC algorithm over Q-algorithm if it is high density tag environment. As seen in graphs and mentioned in the standard, Q-algorithm gives best performance for Q = 4 but QFCC algorithm works well for all the Q values which shows the robustness of QFCC algorithm in all different tag environments. This can also be shown by comparing the values of maximum and minimum efficiency along with the initial Q values used for calculating those efficiencies as shown below.

Table 4.3: Maximum and minimum efficiency values of Gen 2 and QFCC algorithm

Variation	Maximum Efficiency	Q for Maximum Efficiency	Minimum Efficiency	Q for Minimum Efficiency
For N = 100				
Gen 2	0.348505	8	0.314389	2
QSCC	0.349311	2	0.331936	2
QFCC	0.373392	0	0.362053	0
For N = 1000				
Gen 2	0.34774	8	0.330816	2
QSCC	0.352122	8	0.33365	2
QFCC	0.36761	0	0.363991	0

The maximum and minimum values in table 4.3 are the maximum and minimum of average efficiencies. The value of maximum efficiency for QFCC algorithm is 7.14% and 5.71% higher than the maximum efficiency of Gen 2 algorithm for both cases with different number of tags 100 and 1000, respectively. Also, the minimum efficiencies for QFCC algorithm are greater than those of Gen 2 protocol by 15.16% and 10.03% for 100 and 1000 tags, respectively. This shows the improvement in performance of QFCC

algorithm compared to Gen 2 protocol. It also results in decreasing the communication time known as latency, which can be defined as the total time taken for identifying all tags. By calculating the average latency across all trials for different C values for Q-algorithm and QFCC algorithm, we found out that there is a decrease of approximately 3.7% in latency. This shows that QFCC algorithm takes less time to identify the same number of tags compared to Q-algorithm with an initial Q value of 4, which is accepted to be the optimal value for the Q-algorithm. The latencies of both Q and QFCC algorithm are shown in figure 4.11.

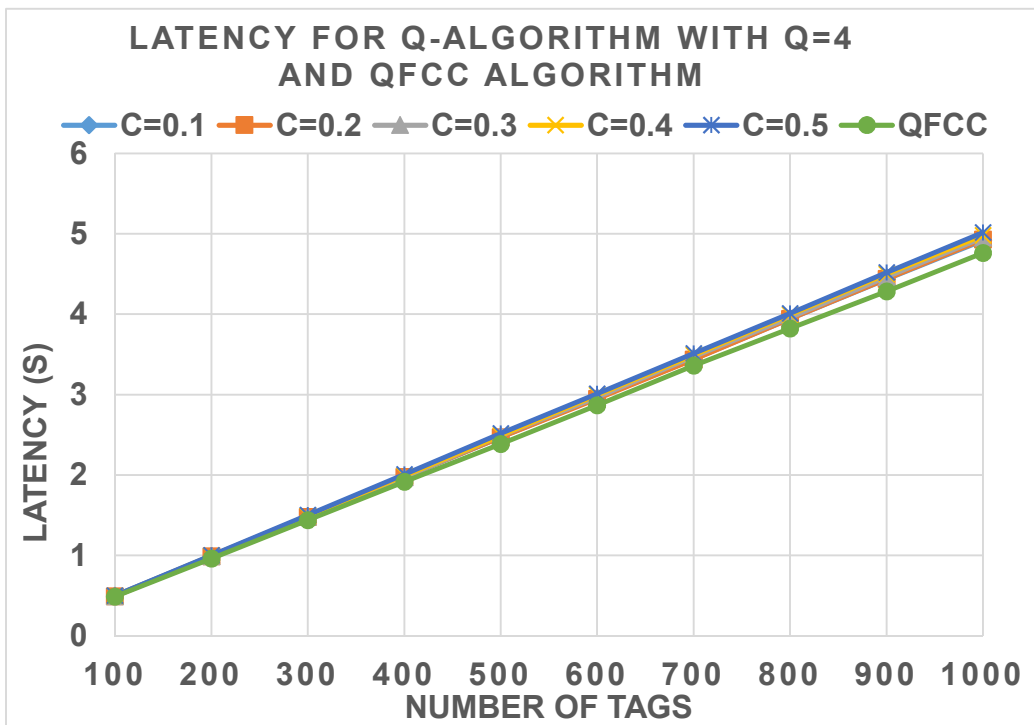

Figure 4.11: Latency for Gen 2 and QFCC algorithm for Q = 4 and N = 100 to 1000

However, there is a limitation to QFCC algorithm. If we take the initial Q value high for less number of tags, then its efficiency will be less than the Gen 2 protocol. Suppose we consider a case for number of tags as N = 10 to 100 and initial Q = 8 and calculate

means of efficiencies for both Gen 2 protocol with different C values and QFCC algorithm.

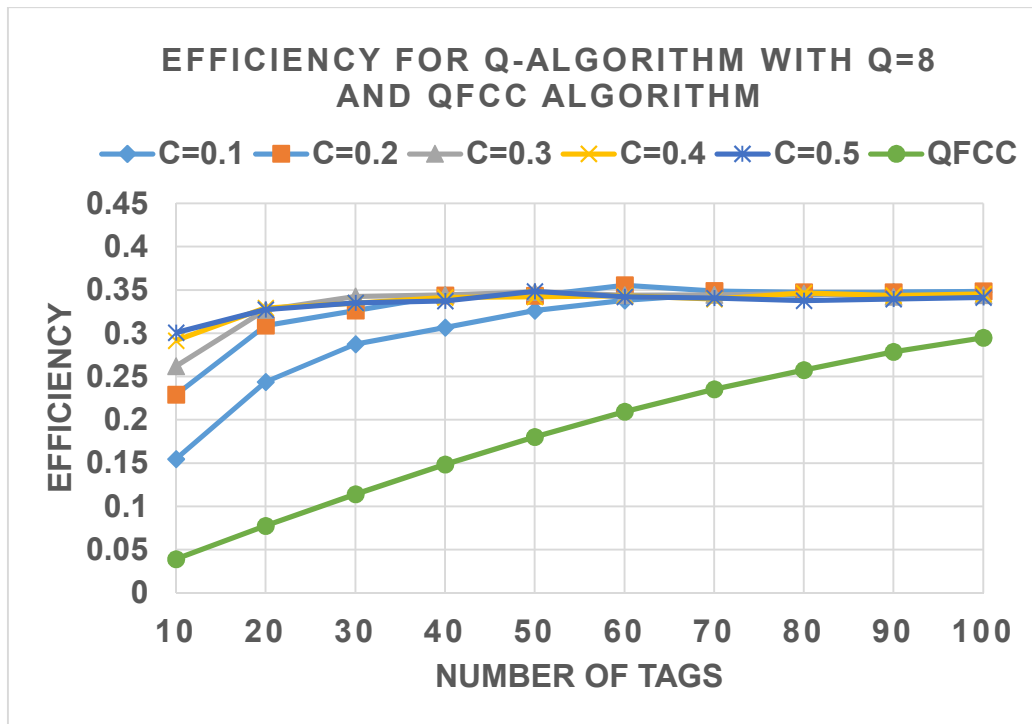

Figure 4.12: Efficiency for Gen 2 and QFCC algorithm for Q = 8 and N = 10 to 100

The graph in figure 4.12 shows that the efficiency of QFCC in such a case is low compared to Gen 2 protocol. This is because the QFCC algorithm modifies the Q value at the end of frame and in this case, it will complete the full frame of size $2^8 = 256$ and then modify the Q value according to number of collisions in these 256 slots. But in case of Gen 2, the Q value will be modified in every slot, and the excess amount of idle frames will result in a reduction of Q value much faster than QFCC algorithm. This will help reduce the number of slots and take less time to identify all the tags.

CHAPTER 5: CONCLUSION

RFID technology is an emerging technology used in a wide variety of applications. As with any wireless technology, utilizing this technology efficiently requires investigating communication issues such as collisions and efficiency. The focus of this thesis has been the frame collisions in RFID systems with the main objective to find a method, which can reduce the number of collisions and increase efficiency of RFID systems. To achieve this goal, most of the existing anti-collision algorithms including the standard Gen 2 protocol were studied to explore what improvements could be done. Three modifications were proposed as a result where one is in the frequency domain while two are in time domain.

The first proposed modification was a 2-fold frequency division approach, which can be used alongside with the existing anti-collision algorithms. In this approach, the RFID UHF frequency range 902-928 MHz is divided into two parts using filters (or in future implementation of selective antennas). Each tag is modified using filters to respond in either of the two frequency ranges of 902-914 MHz and 915-928 MHz. The improvement in efficiency was shown for framed slotted aloha and RSMBA protocol.

The proposed time-domain modifications were updates to the Q-algorithm where the main objective was to modify existing Gen 2 standard without changing the protocol framework such that existing tags and readers could be used as-is. In both of the

proposed protocols, QSCC and QFCC, the communication between reader and tags (such as the inventory cycle) are exactly the same as standard Gen 2 protocol. The only difference is at the reader firmware and how it modifies the Q parameter for adjusting the frame size by counting the number of tags colliding in a time slot for QSCC and the entire frame for QFCC. This makes QFCC independent of the C variable, which is used to modify the Q value in the standard protocol.

The performances of both QSCC and QFCC were analyzed and compared with standard Gen 2 protocol using computer simulations. It was found that QFCC significantly outperformed the standard protocol in terms of efficiency while providing a robust update mechanism, which does not require a foresight of the number of tags in the environment or another parameter adjustment in the form of C.

Future work can look into the implementation of filters on the passive RFID tag to make 2-fold frequency division approach possible via designing selective antennas. Another area of possible future work involves finding more efficient ways than RCS scatter plots to count the number of colliding tags in each time slot to improve QSCC and QFCC algorithms. Moreover, in QFCC algorithm, the feature of early-end can be introduced. This will remove the limitation of QFCC algorithm of not performing well in case of high initial value of the Q parameter as it can only issue frame size updates at the end of the frame. By reducing the idle slot time in frames where idle slots occur a lot more than successful or colliding slots, this will decrease the identification time and improve the efficiency of RFID system.

REFERENCES

- [1] J. Landt, "The history of RFID", IEEE Potentials 24 (4) (2005) 8–11.
- [2] Mark Roberti, "The history of RFID technology", RFID Journal, January 16, 2005, <http://www.rfidjournal.com/articles/view?1338>.
- [3] Want, Roy. "An introduction to RFID technology." Pervasive Computing, IEEE5.1 (2006): 25-33.
- [4] Jonathan Collins, "Japan issues E-passports", RFID Journal, March 28, 2006, <http://www.rfidjournal.com/articles/view?2224>.
- [5] Claire Swedberg, "Grand Rapids Library adopts UHF RFID technology", RFID Journal, September 17, 2012, <http://www.rfidjournal.com/articles/view?9914>.
- [6] Claire Swedberg, "McCarran International Airport expands its RFID Baggage-Handling System", RFID Journal, Aug 10, 2012, <http://www.rfidjournal.com/articles/view?9809>.
- [7] Jill Gambon, "RFID frees up patient beds", RFID Journal, August 28, 2006, <http://www.rfidjournal.com/articles/view?2549>.
- [8] Mark Roberti, "The Lahey Clinic's RFID remedy", RFID Journal, April 17, 2006, <http://www.rfidjournal.com/articles/view?2265>.

[9] Claire Swedberg, "USDA releases RFID Animal-Tracking Project Report", RFID Journal, <http://www.rfidjournal.com/articles/view?3303/2>.

[10] Mark Roberti, "Wal-Mart begins RFID rollout", RFID Journal, April 30, 2004, <http://www.rfidjournal.com/articles/view?926>.

[11] Mark Roberti, "Wal-Mart relaunches EPC RFID effort, starting with men's jeans and basics", RFID Journal, July 23, 2010, <http://www.rfidjournal.com/articles/view?7753>.

[12] Mark Roberti, "Target tests RFID for security", RFID Journal, December 10, 2004, <http://www.rfidjournal.com/articles/view?1282>.

[13] Claire Swedberg, "Porsche uses RFID to track Prototype Testing, improve Security", RFID Journal, February 11, 2015, <http://www.rfidjournal.com/articles/view?12700>.

[14] Mark Roberti, "Airbus enters new phase of RFID usage, Digitalization", RFID Journal, February 23, 2015, <http://www.rfidjournal.com/articles/view?12731>.

[15] Bill Hardgrave, "Apparel Retailers finally get RFID", RFID Journal, April 27, 2014, <http://www.rfidjournal.com/articles/view?11726>.

[16] Mark Roberti, "Apparel edges toward the Tipping Point", RFID Journal, January 6, 2015, <http://www.rfidjournal.com/articles/view?12566>.

[17] Samuel Shaw, "IDriveThru leverages Toll-Tag Technology at Drive-Through Restaurants", RFID Journal, August 22, 2014, <http://www.rfidjournal.com/articles/view?12104>.

[18] "Learning from Prada", RFID Journal, June 24, 2002, <http://www.rfidjournal.com/articles/view?196>.

[19] Claire Swedberg, "MagicBands bring convenience, new services to Walt Disney World", RFID Journal, June 16, 2014, <http://www.rfidjournal.com/articles/view?11877>.

[20] K. Finkenzeller, "RFID Handbook: Fundamentals and Applications in Contactless Smart Cards, Radio Frequency Identification and Near-Field Communication", John Wiley & Sons; 3rd Edition, pg 195.

[21] Klair, Dheeraj K., Kwan-Wu Chin, and Raad. "A survey and tutorial of RFID anti-collision protocols." Communications Surveys & Tutorials, IEEE 12.3 (2010): 400-421.

[22] Abramson, Norman. "THE ALOHA SYSTEM: another alternative for computer communications." Proceedings of the November 17-19, 1970, fall joint computer conference. ACM, 1970.

[23] P4022: Multi Frequency Contactless Identification Device Anti-Collision compatible with BTGs Supertag Category Protocols, EM Microelectronic - MARIN SA

[24] Burdet, Luc Andre. "RFID multiple access methods." Smart Environments Seminar, Zürich, URL:http://www.vs.inf.ethz.ch/edu/SS2004/DS/reports/06_rfid-mac_report.pdf [cited March 2004]. 2004.

[25] Vogt, Harald. "Efficient object identification with passive RFID tags." Pervasive computing. Springer Berlin Heidelberg, 2002. 98-113.

[26] Bin, Z. H. E. N., Mamoru Kobayashi, and Masashi Shimizu. "Framed ALOHA for multiple RFID objects identification." IEICE Transactions on Communications 88.3 (2005): 991-999.

[27] Schoute, Frits C. "Dynamic frame length ALOHA." Communications, IEEE Transactions on 31.4 (1983): 565-568.

[28] Lee, Su-Ryun, Sung-Don Joo, and Chae-Woo Lee. "An enhanced dynamic framed slotted ALOHA algorithm for RFID tag identification." Mobile and Ubiquitous Systems: Networking and Services, 2005. MobiQuitous 2005. The Second Annual International Conference on. IEEE, 2005.

[29] Capetanakis, John. "Tree algorithms for packet broadcast channels." Information Theory, IEEE Transactions on 25.5 (1979): 505-515.

[30] Hush, Don R., and Cliff Wood. "Analysis of tree algorithms for RFID arbitration." IEEE International Symposium on Information Theory. INSTITUTE OF ELECTRICAL ENGINEERS INC (IEEE), 1998.

[31] ISO RFID Standards, <http://www.iso.org/iso/home/standards.htm>

[32] EPC Standards, <http://www.gs1.org/standards>

[33] EPCglobal Specification for RFID Air Interface, "Radio-frequency identity protocols generation-2 UHF RFID protocol for communications at 860 MHz-960 MHz," version 2.0.0, October 2013.

[34] Yihong, Chen, et al. "Multiple-bits-slot reservation aloha protocol for tag identification." Consumer Electronics, IEEE Transactions on 59.1 (2013): 93-100.

[35] Angerer, Christoph, Robert Langwieser, and Markus Rupp. "RFID reader receivers for physical layer collision recovery." *Communications, IEEE Transactions on* 58.12 (2010): 3526-3537.

[36] Khasgiwale, Rushikesh S., Rohan U. Adyanthaya, and Daniel W. Engels. "Extracting information from tag collisions." *RFID, 2009 IEEE International Conference on*. IEEE, 2009.

[37] Landaluce, Hugo, Asier Perallos, and Ignacio Angulo. "A simulation tool for RFID EPC Gen 2 protocol." *Information Systems and Technologies (CISTI), 2012 7th Iberian Conference on*. IEEE, 2012.